

**POWER
TRANSMISSION**





Since 2003, Advantiv have been supplying parts, providing multi skilled engineers and saving energy for clients across all commercial, industrial and manufacturing sectors. We service the UK nationwide, 24 hours a day, 7 days a week, 365 days a year. Our team is made up of experienced staff who know what's needed to provide the service your business expects.

From branches in Newbury and South Wales, Advantiv provide services split across 3 key areas:

- **Industrial MRO parts supply**
- **Engineering Site Services**
- **Energy Efficiency Solutions**

Our supply chain distributorships provide buyers with access to a wide range of MRO products at competitive prices. Our engineering team work with maintenance managers to solve problems and Energy Managers turn to Advantiv to drive down costs whilst complying with legislation.

It's all about understanding your needs, identifying a solution and working in partnership to help you solve that problem. Our aim is to make your investment in Advantiv contribute to your business by reducing your costs, increasing production up time and improving your efficiency.

HEAD OFFICE

Advantiv Limited, Unit 9 Kingfisher Court, Newbury,
Berkshire RG14 5SJ

Tel: 01635 246188 Email: sales@advantiv.co.uk

SOUTH WALES OFFICE

Unit 9 Pant Industrial Estate, Merthyr Tydfil,
Mid Glamorgan CF48 2SR

Tel: 01685 708708 Email: merthyr@advantiv.co.uk

WEST WALES OFFICE

8 Bridge Innovation Centre, Pembroke Science & Technology Park
Pembroke Dock, Pembrokeshire SA72 6UN

Tel: 01646 689211 Email: wales@advantiv.co.uk

Never a problem,
always a...

POWER
TRANSMISSION



 **CHALLENGE** ®



www.challengept.com

Challenge Engineering Pedigree

The Challenge brand represents 40 years of development, manufacture and refinement of the most comprehensive range of quality power transmission and engineered products available from any single source.

Challenge's global network of Regional Distribution Centers act as master importers; supplying Trade and OEMs with quality products on a wholesale-distribution basis. End users are served by their local sub distributor.

Quality, value and service are the foundations of the Challenge brand; we have unparalleled expertise in the manufacture and distribution of engineering products complying with all international standards, tolerances and technical requirements.

All Challenge manufacturing facilities are staffed by experienced engineers who are also able to offer custom made machine parts, ranging from raw castings to the finished product.

Our products are branded and bar coded using the latest technology for ease of replacement, order, stock and dispatch.

So don't forget; Never a problem, always a... ®

Chain



Challenge's extensive range of Roller, Leaf, Timber, Agricultural and Conveyor chains not only offer all the manufacturing refinements and life optimising characteristics that today's engineers and designers expect; they do so without compromise in value or quality.

A full range of attachments are also available as are many types of specially designed chain to suit customer's specific requirements (e.g. sugar, cement, palm oil, bulk material handling etc).

This makes the Challenge chain range the ideal choice for any new build or replacement application.



Sprockets

Sprockets are manufactured to the same exacting standards as Challenge chain. The range includes both taper bore and pilot bore sprockets in simplex, duplex and triplex. Double simplex sprockets are also available.

Challenge offers all standard sprockets ex-stock including BS and ANSI sprockets, plate wheels and idler sprockets.

Special sprockets are manufactured to order according to customer requirements.



Belts

All belts feature international labeling and fully comply with ISO, BS, DIN and other international standards. The extensive Challenge range of quality belts include our:

- Classical V-Belts (Z, A, B, C, D)
- Classical CRE V-Belts (AX, BX)
- Wedge Belts (SPZ, SPA, SPB, SPC, SPP)
- CRE Wedge Belts (SPAX, SPBX, SPCX)
- Narrow V belts (3V, 5V, 8V)
- Classical Timing Belts including sleeves (XL, L, H, XH)
- Curved Tooth Timing Belts including sleeves (HTD in 3M, 5M, 8M and 14M)
- Other belts to suit agricultural and automotive applications are available to special order



Pulleys

The Challenge range of 'V' pulleys are produced with taper bore configuration and conform to ISO 4183. Pulleys are produced from phosphated GG25 grade cast iron and are balanced to Q6.3 or better.

Challenge also manufacture taper bore and pilot bore classical pulleys, HTD and metric timing pulleys, plus special timing pulleys to the same demanding specifications.



Taper Bushes & Hubs

For torque transmission you need the maximum contact area. Challenge's high machining tolerances deliver just that, with over 500 metric and imperial bore sizes of taper bush available and manufactured from close grain cast iron.

To complement our range of shaft fixings, Challenge also manufacture precision machined low carbon steel Weld-on-Hubs, as well as phosphated Bolt-on-Hubs in GG22 cast iron, plus a broad range of keyed and keyless adaptors; ideal for our pilot bored components.



Cone Clamping Elements

Challenge Shaftlock keyless shaft fixings come in a wide range of size and configurations and are simple to install and uninstall.

Challenge Shaftlock is a premium grade locking assembly with high machining tolerances and surface finishes resulting in high torque ratings.



Shaft Mounted Speed Reducers (SMSR)

The workhorse on many conveyors, Challenge's range of metric SMSRs and imperial TXT units are fully interchangeable with other manufacturers and are supplied complete with a torque arm. The Metric SMSR is available with the Grip-Loc hub system or standard output hubs with reducing bushes. The TXT unit is available with a full range of imperial output hub bushings. Backstops for both units are available and sold separately.

Consistent quality and close tolerances are guaranteed by Challenge's production line manufacturing and all units are fully traceable via a unique serial number. Challenge gearboxes are test run for 30 minutes before final quality control and drained of oil before shipment.

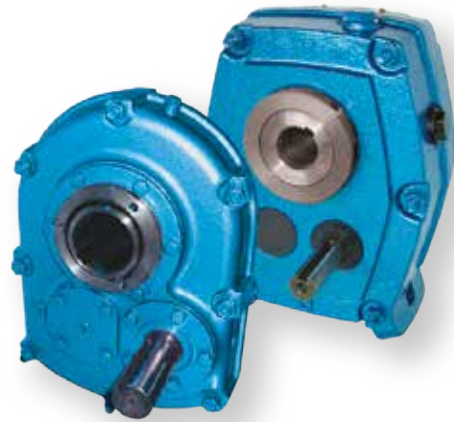

Torque Limiters

The torque limiter range from Challenge will save money in damage and downtime, with its zero manual re-setting and simple installation, this unit works with our plate wheels, sprockets, gears, pulleys, couplings etc.



Shaft Couplings

Challenge shaft couplings are suitable for use in a wide range of applications.

The range encompasses FFX tyre coupling, HRC, Jaw and Chain shaft couplings as well as our NPX, RPX and CNM couplings which match industry standards.

Whether you need to absorb shock from a crusher or drive a smooth running generator, Challenge has a suitable coupling for your application.



Motor Mounts

Manufactured from galvanized steel, Challenge motor mounts maintain your motor's alignment and drive tension, whilst reducing vibration and noise. They are easily adjustable and available in five motor frame sizes covering 63 to 180.

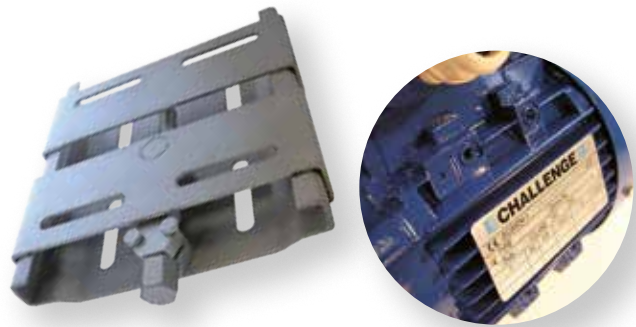

POWER
TRANSMISSION

Electric Motors

The Challenge range of three phase electric motors comply with IEC 60034 standards and are available in IE1, IE2 and IE3 efficiencies. The motors are approved having fan cooled, high grade cast aluminium alloy squirrel caged construction, incorporating engineering grade plastic terminal boxes. All motors have multi-mount feet and thus can achieve numerous mounting positions.



Worm Gear Units

Challenge offer a range of worm gear units with aluminium alloy cases. This extremely versatile unit can be offered with output shafts, electric motors, input flanges, torque arms with many different configurations to fulfil most application criteria. The sizes match industry standards.



Bearings

Our range of bearings includes metric 1600, 6000, 6200, 6300 and 6800/6900 series, and R series imperial bearings. All our roller bearings are shielded for longer life and ease of maintenance. We also stock a popular range of metric and imperial taper roller bearings and spherical roller bearings. Special + non standard bearings are available upon request.



Bearing Units

Challenge Triple Seal Pillow blocks, 2 and 4 hole flange units and take-up units all have triple lipped seals fitted as standard. These triple seals ensure the longevity of these bearing units and make them ideal for high dust environments such as in agriculture, mining and quarrying applications. Additional options include: pressed steel housings, plastic housings + stainless steel housings + inserts.

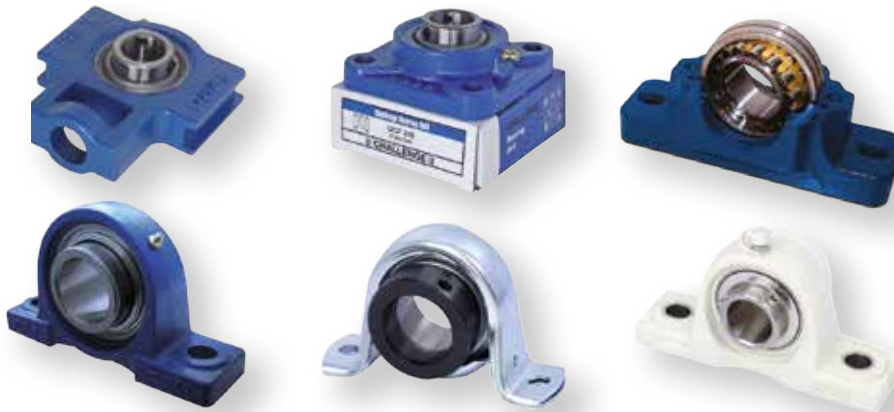

Agri Range



Challenge AGRI Chain – These chains for agricultural machinery are fully interchangeable with major machinery manufacturers and are aimed at the replacement market. Incorporating the most advanced heat treatment processes and a special lubricant, these chains are engineered specifically to cope with the conditions persistent in agricultural applications.

Challenge AGRI Bearings – This expanding range consists mainly of industry standard bearing units with double lipped seals and wheel bearing kits for specific machines. These industry standard bearings are manufactured using chromium bearing steels and filled with proprietary lithium based grease.



Challenge AGRI Belts – This range of high quality fan and drive belts for agricultural machinery are produced to the same exacting specification as our standard range of V and Wedge belts. Top quality together with excellent stock availability and reasonable pricing mean that these popular belts are quickly becoming the standard for agricultural users around the world.

The new generation Challenge hub for tillage, seeding and marking discs with a special sealing arrangement and brand new range of PTO units are also available within our agricultural range.



Challenge Technical Catalogue

The Challenge Power Transmission Technical Catalogue covers our entire range of products in our 430 page publication. Contact your local Challenge Sales office for your copy now.



Never a problem always a ...

CHALLENGE[®]
www.challengept.com

POWER
TRANSMISSION

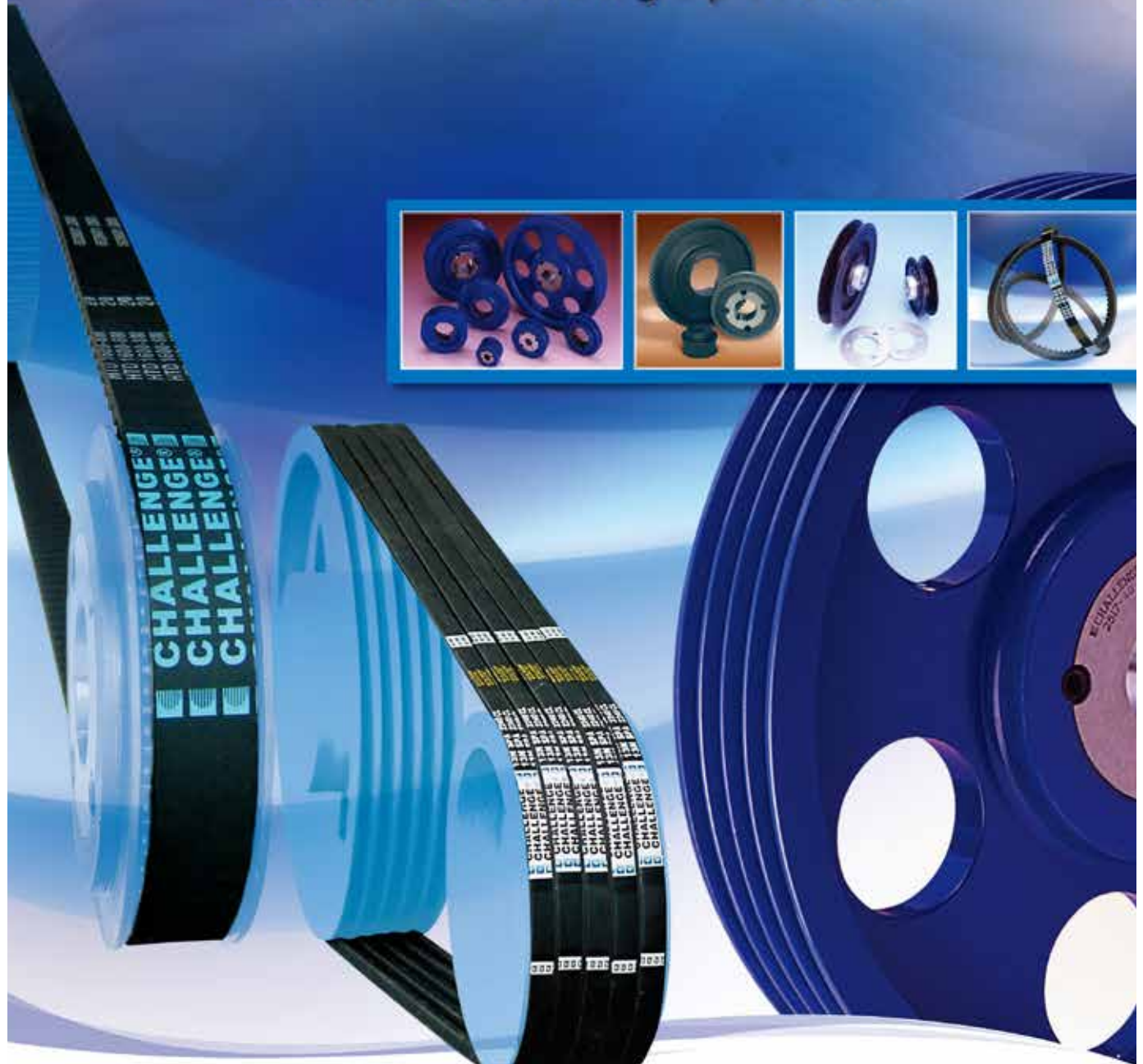

Belt Drives

CHALLENGE[®]
www.challengept.com



Never a problem always a ...

CHALLENGE®

www.challengept.com



**Chain
Drives**

CHALLENGE
www.challengept.com



Never a problem always a ...

CHALLENGE[®]
www.challengept.com



Couplings

CHALLENGE[®]
www.challengept.com



Never a problem always a ...

CHALLENGE[®]
www.challengept.com



Shaft Fixings

CHALLENGE[®]
www.challengept.com





Flange Units



Plummer Blocks



Bolt on Hubs



Taper Bore Pulleys



Pillow blocks



Electric Motors



AFX Couplings



Pop Metric Bearings

Taper Roller Bearings



Conveyor Sprockets



Taper bushes



Torque Limiters



Timing Pulleys

THE WIDEST RANGE OF
POWER TRANSMISSION
PRODUCTS UNDER
ONE BRAND



Weld on Hubs

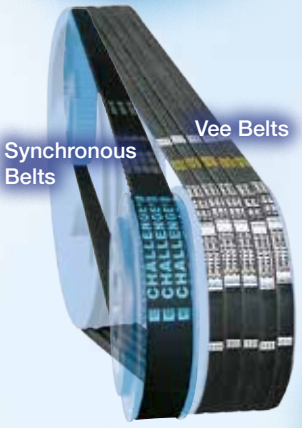

Synchronous Belts

Vee Belts



Clamping Elements



Transmission Sprockets

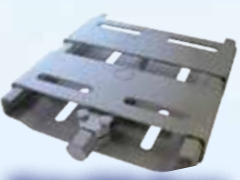

Motor Slide Bases



Geared Drives



Shaft Mounted Speed Reducers



All types of Chain



Leaf Chain



CRE Belts



RPX Couplings



HRC Couplings



CNM Couplings



Jaw Couplings



Chain Couplings



NPX Couplings

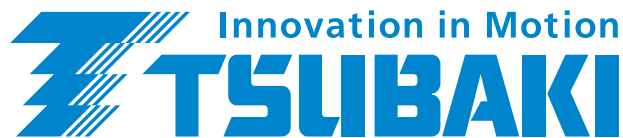

JAPANESE PRECISION



Located in Kansai Science City, the Kyotanabe plant embodies our wide spectrum of cutting-edge technological solutions. Our aim is to develop this environmentally friendly facility into the world's number one chain plant. Furthermore, Kyotanabe's Technical Centre plays a vital role within the Tsubaki Group through its R&D activities and distribution of knowledge. The Kyotanabe plant is an excellent example of a facility built on the foundation of Tsubaki's technical expertise.



Consideration for the Global Environment

The Tsubaki Group is working to conserve the environment and reduce the environmental impact of its operations by improving the efficiency of its manufacturing activities.



In addition, the Tsubaki Group will continually take on the challenge of sustainable value creation by advancing the development of environmentally friendly products.

These eco-products help customers reduce energy consumption and improve the economic aspects of their operations.

About TSUBAKI

Established in 1917, Tsubakimoto Chain Company is the world's premier manufacturer of power transmission products with strong market positions in premium quality ANSI & BS roller conveyor & engineering chains and associated power transmission components such as Cam Clutches, reducers & linear actuators.

At TSUBAKI we know that customers want the best. Indeed, we take pride in our ability to deliver an extensive product lineup that satisfies these high expectations. We are also aware that each and every one of our customers has unique requirements. Our focus is on providing our customers around the world with concrete solutions by developing products to suit different countries, regions and business environments. Tsubakimoto UK in Nottingham, serves the markets of the UK, Ireland and Iceland.

Stockholding UK/Europe

TSUBAKI stocks a wide range of standard power transmission products; many of which provide innovative solutions. We pride ourselves on customer service excellence and understand the importance of having stock available to fulfil our customer's requirements. The UK and European warehouse hold stock in excess of £1.8m and offer a wide product range of drive, conveyor, attachment chains & sprockets. We also supply power transmission component products such as Cam Clutches, torque limiters and couplings.

tsubaki.eu

TSUBAKI SOLUTIONS LINE-UP



POWER TRANSMISSION



GT4 Winner: General Purpose

- Seamless bushing and lubrication grooves to improve wear resistance
- Centre sink pin rivet for easy disassembly
- Ring coined connecting link for maximum transmission capacity



Lambda: Lube Free

- Provides low maintenance and clean operation, no external lubrication required
- Bushing impregnated with lubrication for improved wear resistance
- Centre sink pin rivet for easy disassembly
- Ring coined connecting link for maximum transmission capacity



Titan: Anti Dust and Abrasives

- Special coated pin for wear resistance in harsh/dusty applications
- Seamless bushing and lubrication grooves to improve wear resistance
- Centre sink pin rivet for easy disassembly
- Ring coined connecting link for maximum transmission capacity



HEAVY DUTY

Heavy Series: Increased Strength

- Extra transmission capacity
- Highly resistant to shock loads
- Superior tensile strength and fatigue resistance
- Extended life due to perfectly cylindrical solid bush



NEPTUNE™

Neptune: Anti Corrosion

- Special coating provides excellent corrosion protection
- Resists common food industry wash down chemicals and salt water
- Seamless bushing and lubrication grooves to improve wear resistance
- Centre sink pin rivet for easy disassembly
- Ring coined connecting link for maximum transmission capacity



PC CHAIN

PC Chain: Anti Corrosion

- Stainless Steel links to resist corrosion
- Engineering plastic provides self lubrication
- Light weight and low noise



STAINLESS STEEL

Stainless Steel: Anti Corrosion

- Highly resistant in corrosive environments
- Wide temperature range (-20 degC to 400 degC)
- All components made of 304SS austenite stainless steel (SUS304)

ROLLER CHAIN GT4 WINNER

TSUBAKI GT4 Winner is the most advanced BS/DIN standard roller chain in the European market. Since 1917 Tsubakimoto Chain Company has maintained a line-up of cutting-edge chain products with exceptional quality and performance. TSUBAKI is proud of the 4th generation, enhanced European premium BS/DIN chain.

Advantages

TSUBAKI RS roller chain GT4 Winner is enhanced with the following advantages:

Wear resistance

TSUBAKI's patented LG (Lube Groove) seamless bushes are precision components and perfectly cylindrical. Our special lube grooves hold oil at the point of contact, where the chain needs it most. The result is a chain that lasts longer with lower maintenance costs over the lifetime of the chain. The Lube Groove is applied to RS16B, RS20B and RS24B.

Easy disassembling with centre sink pin design

The chains can be easily and safely disassembled with a standard screw type cutter without damaging bushes. Center sink riveting is applied to RS08B up to RS16B single strand chain.

Increased kW Rating

The TSUBAKI Ring Coining process on the connecting link plate allows the chain to be specified up to its full kW rating.



Ring Coined Connecting Link Plate

In general, connecting links have a 20% lower fatigue strength than the chain itself. However, TSUBAKI developed a special process to eliminate that loss of fatigue strength and still satisfy the customers demand for easy assembly: the Ring Coining process. Generating a cold deformation around the pin hole of the connecting link plate results in residual stress around this region, thereby adding strength. By using this process we can achieve 100% transmission capacity of the base chain.

Constant Quality Level

In pursuit of outstanding quality, every TSUBAKI chain is made of a special steel alloy, the specification of which has been developed by the TSUBAKI engineering department for selected steel mills to work with. TSUBAKI produces the GT4 Winner under highly controlled conditions in its advanced heat treatment facilities. This, in combination with TSUBAKI fatigue strength tests, ensures that our customers can always rely on a constant level of quality whenever using TSUBAKI products.

Customized Pre-Lubrication Service

Proper lubrication is the key to extending the life and improving the performance of a chain. In order to get the best performance in general applications (-10°C to +60°C), all GT4 Winner drive chains are pre-lubricated.

For special applications, TSUBAKI can provide chains which are pre-lubricated with a special lubricant on customer demand:

- High temperature
- Low temperature
- Food safe
- Outdoor exposure
- Dusty environment

Please consult TSUBAKI for more detailed information.



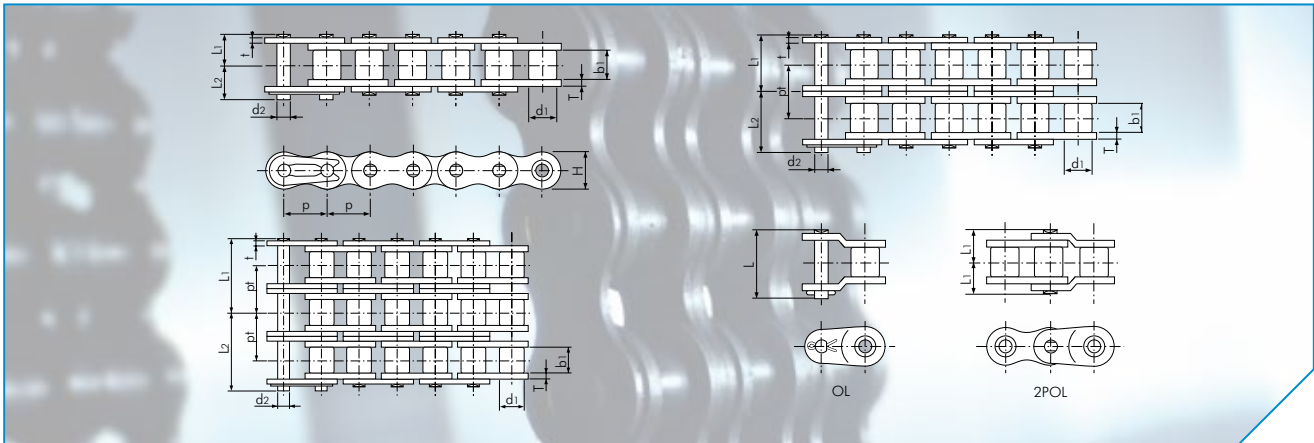

POWER TRANSMISSION

GT4 WINNER

Dimensions in mm

TSUBAKI Chain No.	Pitch p	Roller Diameter d1	Inner Width b1	Pin			Link Plate			Transverse Pitch pt	Min. Tensile Strength acc. to ISO 606 kN	Min. Tensile Strength acc. to TSUBAKI kN	Approx. Mass kg/m			
				Diameter d2	Length L1	Length L2	Length L	Thickness T	Thickness t					Height H (max)		
RS05B-1	8.00 (0.315")	5.00	3.00	2.30	3.80	4.70	-	0.75	0.75	7.10	-	4.4	5.0	0.18		
RS05B-2					6.65	7.55	-				5.64	7.8	7.8	0.35		
RS05B-3					9.45	10.35	-				5.64	11.1	11.1	0.53		
RF06B-1	9.525 (3/8")	6.35	5.72	3.27	6.10	7.70	15.10	1.30	1.00	8.20	-	8.9	9.0	0.39		
RF06B-2					11.20	12.80	25.90				10.24	16.9	17.0	0.75		
RF06B-3					16.40	17.90	36.10				10.24	24.9	24.9	1.11		
RS08B-1	12.70 (1/2")	8.51	7.75	4.45	8.40	10.00	18.60	1.60	1.60	11.80	-	17.8	19.0	0.70		
RS08B-2					15.30	16.90	34.50				13.92	31.1	32.0	1.35		
RS08B-3					22.25	23.85	48.40				13.92	44.5	47.5	2.00		
RS10B-1	15.875 (5/8")	10.16	9.65	5.08	9.55	11.25	20.80	1.50	1.50	14.70	-	22.2	23.0	0.95		
RS10B-2					17.85	19.55	39.40				16.59	44.5	44.5	1.85		
RS10B-3					26.15	27.85	56.00				16.59	66.7	66.8	2.80		
RS12B-1	19.05 (3/4")	12.07	11.68	5.72	11.10	13.00	24.40	1.80	1.80	16.10	-	28.9	31.0	1.25		
RS12B-2					20.85	22.75	45.90				19.46	57.8	61.0	2.50		
RS12B-3					30.60	32.50	65.40				19.46	86.7	92.0	3.80		
RS16B-1	25.40 (1")	15.88	17.02	8.28	17.75	19.95	41.10	4.00	3.20	21.00	-	60.0	70.0	2.70		
RS16B-2					33.55	35.75	75.20				31.88	106.0	128.0	5.40		
RS16B-3					49.50	51.70	107.10				31.88	160.0	192.0	8.00		
RS20B-1	31.75 (1 1/4")	19.05	19.56	10.19	19.90	23.10	46.60	4.40	3.40	26.00	-	95.0	98.1	3.85		
RS20B-2					38.25	41.45	84.60				36.45	170.0	197.0	7.65		
RS20B-3					56.50	59.70	121.00				36.45	250.0	295.0	11.45		
RS24B-1	38.10 (1 1/2")	25.40	25.40	14.63	26.65	31.85	61.70	6.00	5.60	33.40	-	160.0	167.0	7.45		
RS24B-H-1					29.30	34.20	-				7.50	6.00	36.20	-	234.0	8.20
RS24B-2					50.80	56.00	112.80				48.36	280.0	335.0	14.65		
RS24B-3	75.10	80.20	161.10	48.36	425.0	500.0	21.75									
RS28B-1	44.45 (1 3/4")	27.94	30.99	15.90	32.45	37.45	74.40	7.50	6.30	36.40	-	200.0	200.0	9.45		
RS28B-2					62.15	67.15	136.60				59.56	360.0	374.0	18.80		
RS28B-3					91.95	96.95	195.90				59.56	530.0	560.0	28.20		
RS32B-1	50.80 (2")	29.21	30.99	17.81	32.10	37.70	73.30	7.00	6.30	42.20	-	250.0	255.0	10.25		
RS32B-2					61.25	66.85	134.50				58.55	450.0	485.0	20.10		
RS32B-3					90.50	96.10	192.60				58.55	670.0	729.0	29.90		
RS40B-1	63.50 (2 1/2")	39.37	38.10	22.89	39.25	45.05	88.60	8.50	8.00	52.90	-	355.0	373.0	16.35		
RS40B-2					75.40	81.20	163.20				72.29	630.0	716.0	32.00		
RS40B-3					111.50	117.30	235.30				72.29	950.0	1080.0	47.75		
RS48B-1	76.20 (3")	48.26	45.72	29.23	49.30	58.80	117.70	12.10	10.00	63.80	-	565.0	565.0	25.00		
RS48B-2					95.00	104.40	209.00				91.21	1000.0	1000.0	50.00		
RS48B-3					140.60	150.00	300.20				91.21	1500.0	1520.0	75.00		

Note:

- For sizes RS16B - RS24B Lube Grooves (LG) are applied
- Connecting links are clip type for sizes up to RS16B, and cotter type for sizes RS20B to RS48B.
- RF06B chain has flat-shaped link plates.
- Intermediate plate of multi strand RF06B-2 and RS08B-2 chain is a solid plate.
- Center sink riveting is applied to RS08B-1 to RS16B-1 single strand chain.
- Double stake riveting is applied to all other sizes including multi-strand chain.
- When a single pitch offset link is used, please calculate a 40% reduction of the fatigue strength.
- RS24B-H-1 chain is a reinforced RS24B-1 chain.

LAMBDA LUBE FREE ROLLER CHAIN

TSUBAKI's LAMBDA Chains were the first in the industry to use a special oil impregnated bush. Since their launch in 1988, they have been adopted for diverse industries and applications, and their performance has been highly rated. TSUBAKI has a wide line-up of lube-free, long life products that help customers reduce costs.

Technical Evolution

As a pioneer in the lube-free chain market, TSUBAKI will reveal some of the key elements behind LAMBDA's outstanding performance:

Sintered Oil Impregnated Bush

The microscopic pores in the seamless sintered bush are vacuum filled with high performance NSF-H1 lubricant. This innovation provides a 30%* longer wear life.

* Average increase compared to the previous generation of Lambda chain.

Special Coated Pin

The special coating on the pin surface enhances the long term internal lubrication.

Centre Sink Rivet

The unique centre sink pin design offers easy chain disassembly and the markings on the rivet head will identify pin rotation.

Ring Coin

The Ring Coin connecting link ensures that the chain can be specified up to its full chain capacity.

Special Environments

TSUBAKI LAMBDA has outstanding performance in temperatures up to +150°C.

For temperatures above +150°C: Due to special NSF-H1 certified lubrication impregnated bushes, TSUBAKI LAMBDA KF Series is usable in a wide temperature range (from -10°C to +230°C) while at the same time being kind to the environment. Please consult TSUBAKI for more detailed information.

Advantages

TSUBAKI has enhanced the LAMBDA with the following advantages:

Save Maintenance Costs

No expensive labour costs as it is not required to manually lubricate this chain.

Save Purchasing Costs

Lower frequency of purchasing due to the high quality of the chain and its long economic life. No purchasing of lubricants or lubrication systems necessary.

Higher Productivity

No unforeseen downtime due to chain breakdown. Less time required for maintenance and therefore more time for production.

Environmental Friendly

Applications run clean thus reducing the risk of contaminating products, machines, floor etc. In addition, the LAMBDA chain is ideally suited for food industry applications due to the use of a NSF-H1 lubricant.

Interchangeability

Chains:

BS LAMBDA Chains are fully interchangeable with standard BS roller chains.

Sprockets:

Standard BS roller chain sprockets can be used. However, due to the extended lifetime of BS LAMBDA chain, TSUBAKI recommends to install sprockets with hardened teeth in every LAMBDA application.



Basic Construction

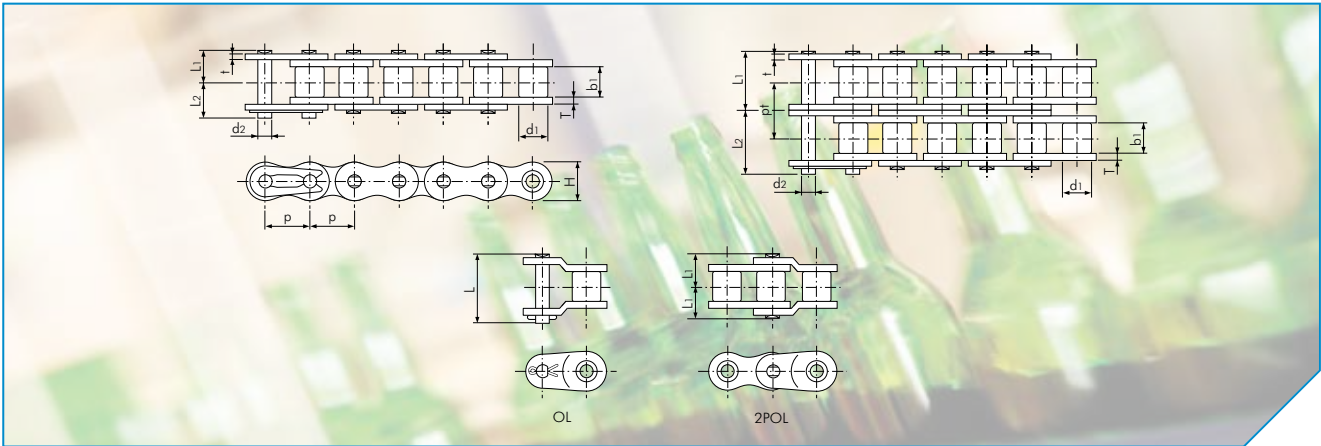

POWER TRANSMISSION

BS LAMBDA Chain

Dimensions in mm

TSUBAKI Chain No.	Pitch p	Roller Diameter d1	Inner Width b1	Pin			Link Plate			Transverse Pitch pt	Min. Tensile Strength acc. to ISO 606 kN	Approx. Mass kg/m	
				Diameter d2	Length L1	Length L2	Length L	Thickness T	Thickness t				Height H (max)
RF06B-1M-1	9.525 (3/8")	6.35	5.72	3.28	6.10	7.70	15.10	1.30	1.00	8.20	-	8.9	0.39
RF06B-1M-2					11.20	12.80	25.90				10.24	16.9	0.75
RS08B-1M-1	12.70 (1/2")	8.51	7.75	4.45	8.40	10.00	18.60	1.60	1.60	11.80	-	17.8	0.70
RS08B-1M-2					15.30	16.90	34.50				13.92	31.1	1.35
RS10B-1M-1	15.875 (5/8")	10.16	9.65	5.08	9.55	11.25	20.80	1.50	1.50	14.70	-	22.2	0.95
RS10B-1M-2					17.85	19.55	39.40				16.59	44.5	1.85
RS12B-1M-1	19.05 (3/4")	12.07	11.68	5.72	11.10	13.00	24.40	1.80	1.80	16.10	-	28.9	1.25
RS12B-1M-2					20.85	22.75	45.90				19.46	57.8	2.50
RS16B-1M-1	25.40 (1")	15.88	17.02	8.28	17.75	19.95	41.10	4.00	3.20	21.00	-	60.0	2.70
RS16B-1M-2					33.55	35.75	75.20				31.88	106.0	5.40
RS20B-1M-1	31.75 (1 1/4")	19.05	19.56	10.19	19.90	23.10	46.60	4.40	3.40	26.40	-	95.0	3.85
RS20B-1M-2					38.25	41.45	84.60				36.45	170.0	7.65
RS24B-1M-1	38.10 (1 1/2")	25.40	25.40	14.63	26.65	31.85	61.70	6.00	5.60	33.40	-	160.0	7.45
RS24B-1M-2					50.80	56.00	112.80				48.36	280.0	14.65

ANSI LAMBDA Chain

Dimensions in mm

TSUBAKI Chain No.	Pitch p	Roller Diameter d1	Inner Width b1	Pin			Link Plate			Transverse Pitch pt	Min. Tensile Strength acc. to TSUBAKI kN	Approx. Mass kg/m	
				Diameter d2	Length L1	Length L2	Length L	Thickness T	Thickness t				Height H (max)
RS40-1MD-1	12.70 (1/2")	7.92	7.55	3.97	8.75	10.45	20.00	2.00	1.50	12.00	-	17.7	0.70
RS40-1MD-2					16.50	18.10	-				15.40	35.3	1.40
RS50-1MD-1	15.875 (5/8")	10.16	9.26	5.09	10.75	12.45	24.00	2.40	2.00	15.00	-	28.4	1.11
RS50-1MD-2					20.20	22.00	-				19.00	56.9	2.20
RS60-1MD-1	19.05 (3/4")	11.91	12.28	5.96	13.70	15.70	32.00	3.20	2.40	18.10	-	40.2	1.72
RS60-1MD-2					26.05	28.05	-				24.52	80.4	3.40
RS80-1MD-1	25.40 (1")	15.88	15.48	7.94	17.15	20.25	39.90	4.00	3.20	24.10	-	71.6	2.77
RS80-1MD-2					32.70	35.90	-				31.10	143.0	5.50
RS100-1MD-1	31.75 (1 1/4")	19.05	18.70	9.54	20.65	23.85	47.50	4.80	4.00	30.10	-	107.0	4.30
RS100-1MD-2					39.50	42.50	-				37.60	214.0	8.60
RS120-1MD-1	38.10 (1 1/2")	22.23	24.75	11.11	25.75	29.95	59.00	5.60	4.80	36.20	-	148.0	6.40
RS140-1MD-1					44.45	32.20	63.70				6.40	5.60	42.20

TITAN
TSUBAKI TITAN CHAINS

OUR LATEST INNOVATION

TSUBAKI Titan chain is the latest innovation from TSUBAKI's research & development with the goal to increase wear life in harsh conditions that cause dust contamination and abrasion.

Our TSUBAKI Titan chain combines the best features of our general purpose GT4 Winner chain with new and unique specifications, delivering the ultimate in wear performance.

Chain features

Special Coated Pins

Special coated pins provide an extra hard and low friction surface, thus increasing wear life. As a result, maintenance cost, downtime and the Total Cost of Ownership are reduced to a minimum.

Seamless Bushes with Lube Grooves

TSUBAKI LG (Lube Groove) seamless bushes are precision components and perfectly cylindrical. The special Lube Grooves hold oil at the point of contact, where the chain needs it most. This limits the wear between pin and bush, significantly improving the wear life as a result.

Corrosion Resistance

Nickel plated outer link plates combined with blackoxide inner link plates provide an extra layer of protection against corrosion.

Ring Coin

TSUBAKI's unique Ring Coin Connecting Links ensure that the chain can be specified up to its full capacity.



1 Lube Grooves (LG)
RS16B - RS24B

2 Seamless Bush

3 Special Coated Pin

4 Nickel Plated Outer
Link Plates

5 Ring Coin



Selecting the right chain for the job is often overlooked. Harsh conditions where dust / abrasive particles infiltrate moving parts significantly shorten the lifetime of standard chain. This results in high cost caused by downtime, production loss, replacement parts & labour.

The TSUBAKI Titan chain is specially developed to deliver the ultimate wear performance in these harsh conditions. The resulting longer intervals between maintenance / replacement work will notably reduce your Total Cost of Ownership.

ANTI DUST & ABRASIVES

NEPTUNE
ANTI
CORROSION

HEAVY DUTY
SHOCK
RESISTANT



LAMBDA
LUBE FREE

Typical uses for TSUBAKI Titan chain include:

- Sawmills / wood processing
- Brick / tile manufacturing
- Gypsum board manufacturing
- Mining
- Metal working
- Cement processing
- Sugar processing
- Paper processing

ANSI HEAVY DUTY ROLLER CHAIN

The superior performance of TSUBAKI Heavy Duty chains is the result of a comprehensive quality control network that begins with selection of the world's finest steel materials. It continues with inspection and analysis of quality and performance in 20 different work areas. At TSUBAKI quality control is not just a one time check; it is a total dedication. It is your assurance of long lasting and dependable performance.

TSUBAKI offers Heavy Duty chains for applications that exceed the capabilities of TSUBAKI ANSI G8 standard roller chain. Heavy Duty chain should be considered in the following situations:

1. Harsh environments where the chain will be subjected to heavy impact.
2. Compact drives for equipment or machines that must work in tight spaces.
3. When higher transmission power, allowable load or tensile strength is required.
4. When a lower rate of elastic elongation is required.

H Series

H Series chain differs only from the ANSI G8 Series chain in the thickness of the link plates. The link plates have the same thickness as the link plates of the next larger pitch size in ANSI G8 Series. The increased thickness of the link plates provides a 10% greater capacity for fatigue strength. In addition, the solid bushes provide twice the wear life on average compared to the previous generation. In short, H Series chains are especially suitable for situations where the load is heavy and operating speed is low (up to 50 m/min) or where operating conditions are severe.

HT Series

HT Series chain provides a (10% to 20%) higher Tensile Strength than ANSI G8 Series chain by using through-hardened pins and link plates of the next larger pitch size in ANSI G8 series. The solid bushes provide twice the wear life on average compared to the previous generation. HT Series chain also provides a higher fatigue strength and is best suited for low operating speeds - up to 50 m/min. Dimensions of the chain are identical to the H Series chain.

SUPER Series

The dimensions of these series are identical to those of ANSI G8 Series chain. The special design of the SUPER Series link plate delivers exceptional performance. The pin holes are critically formed and ball drifted and the pins are through-hardened for greater fatigue strength (40%). SUPER Series chains offer 10% higher tensile strength than the equivalent size ANSI G8 Series chain. SUPER Series chains can be used to replace the next larger pitch size of ANSI G8 Series, making them ideal for applications where chain space is limited. Best suited for low

SUPER-H Series

The thickness of the SUPER-H Series link plates is the same as the next larger pitch size of SUPER Series chain. The pins are also through-hardened which provides a higher tensile strength (12%*). Higher fatigue strength (15%*) is achieved by Ring Coining on the inner plates. The pin holes are critically formed and ball drifted. SUPER-H Series chains can be used to replace the next larger size of ANSI standard chain, making them ideal for applications where space is limited. Best suited for low speed operating conditions - up to 50 m/min.

* Average increase in comparison with the SUPER Series.

ULTRA SUPER Series

ULTRA SUPER Series offer longer wear life, greater fatigue strength (>60%) and higher tensile strength (>45%) than any other TSUBAKI roller chain. The pins are through-hardened and the pin holes are critically formed and ball drifted. This chain is well suited for applications where there are space limitations. The heavy duty construction of the ULTRA SUPER Series chain allows it to replace chains up to two pitch sizes larger ANSI G8 Series chain. It is best suited for low speed operating conditions up to 50 m/min.

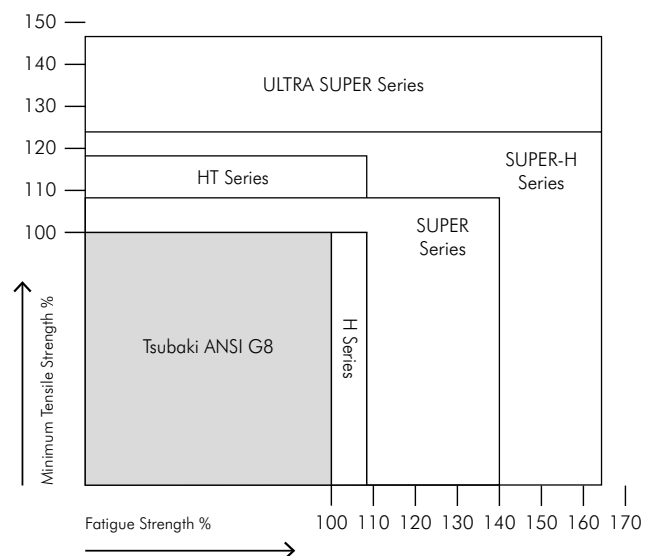

Comparison of Tensile Strength / Fatigue Strength

HEAVY DUTY

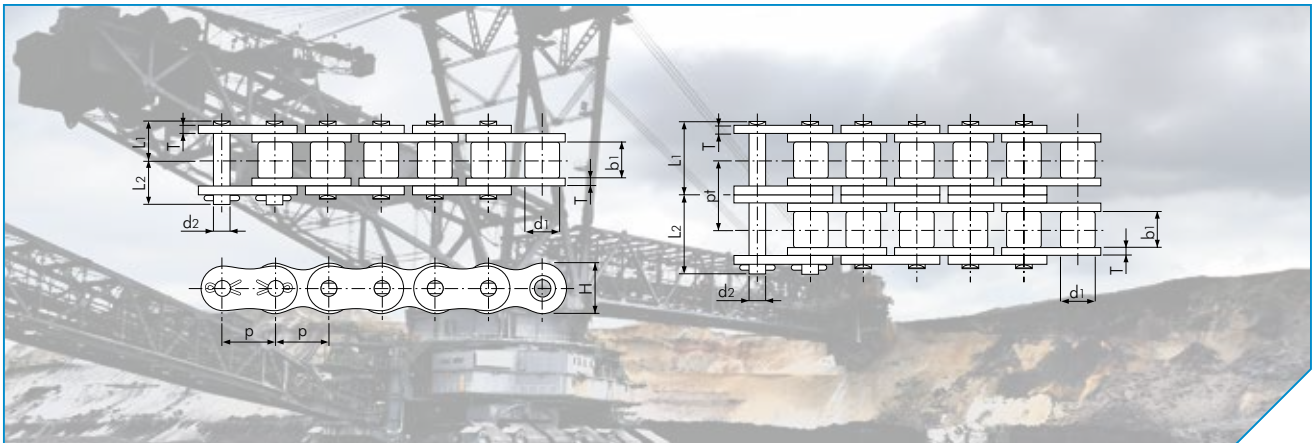

POWER TRANSMISSION

H Series

Dimensions in mm

TSUBAKI Chain No.	Pitch p	Roller Diameter d1	Inner Width b1	Pin			Link Plate		Transverse Pitch pt	Min. Tensile Strength acc. to TSUBAKI kN	Approx. Mass kg/m
				Diameter d2	Length L1	Length L2	Thickness T	Height H (max)			
RS60-H1	19.05 (3/4")	11.91	12.70	5.96	14.80	17.00	3.20	18.10	-	40.2	1.80
RS60-H2					27.80	29.90			26.10	80.4	3.59
RS80-H1	25.40 (1")	15.88	15.88	7.94	18.30	20.90	4.00	24.10	-	71.6	3.11
RS80-H2					34.60	37.20			32.60	143.0	6.18
RS100-H1	31.75 (1 1/4")	19.05	19.05	9.54	21.80	24.50	4.80	30.10	-	107.0	4.58
RS100-H2					41.40	44.10			39.10	214.0	9.03
RS120-H1	38.10 (1 1/2")	22.23	25.40	11.11	26.95	30.55	5.60	36.20	-	148.0	6.53
RS120-H2					51.40	55.00			48.90	296.0	12.90
RS140-H1	44.45 (1 3/4")	25.40	25.40	12.71	28.90	33.10	6.40	42.20	-	193.0	8.27
RS140-H2					55.00	59.50			52.20	386.0	16.38
RS160-H1	50.80 (2")	28.58	31.75	14.29	33.95	38.45	7.15	48.20	-	255.0	10.97
RS160-H2					64.90	69.60			61.90	510.0	21.78
RS200-H1	63.50 (2 1/2")	39.68	38.10	19.85	42.90	48.10	9.50	60.30	-	427.0	18.41

SUPER Series

Dimensions in mm

TSUBAKI Chain No.	Pitch p	Roller Diameter d1	Inner Width b1	Pin			Link Plate		Transverse Pitch pt	Min. Tensile Strength acc. to TSUBAKI kN	Av. Tensile Strength acc. to TSUBAKI kN	Approx. Mass kg/m	
				Diameter d2	Length L1	Length L2	Length L	Thickness T					Height H (max)
RS80-SUP-1	25.40 (1")	15.88	15.88	7.94	16.25	19.25	39.30	3.20	24.10	-	74.2	85.3	2.81
RS80-SUP-2					30.90	33.90	-			29.30	148.0	171.0	5.62
RS100-SUP-1	31.75 (1 1/4")	19.05	19.05	9.54	19.75	22.85	48.00	4.00	30.10	-	111.0	127.0	4.25
RS100-SUP-2					37.70	40.80	-			35.80	222.0	255.0	8.38
RS120-SUP-1	38.10 (1 1/2")	22.23	25.40	11.11	24.90	28.90	59.90	4.80	36.20	-	162.0	186.0	6.30
RS120-SUP-2					47.60	51.60	-			45.40	324.0	373.0	12.44
RS140-SUP-1	44.45 (1 3/4")	25.40	25.40	12.71	26.90	31.70	65.70	5.60	42.20	-	213.0	245.0	8.04
RS160-SUP-1	50.80 (2")	28.58	31.75	14.29	31.85	36.85	77.20	6.40	48.20	-	273.0	314.0	10.79
RS200-SUP-1	63.50 (2 1/2")	39.68	38.10	19.85	39.00	44.80	94.90	8.00	60.30	-	439.0	505.0	17.63
RS240-SUP-1	76.20 (3")	47.63	47.63	23.81	47.90	55.50	116.00	9.50	72.40	-	639.0	735.0	25.63

CHAIN FOR CORROSIVE ENVIRONMENTS

Whether your operation requires a sanitary environment, is exposed to corrosive chemicals, is heated to extreme temperatures, runs through a freezer, is exposed to the outdoors or is affected by excessive moisture: our specially designed and tested chains will outlast your current chains and contribute to a cost effective application.

Corrosion Resistant Chain (Stainless Steel base)

BS PC Engineering Plastic Combination Chain

The pins and pin link plates of these chains are made of SUS304 equivalent (spring clips SUS301). Engineering plastic (white) is used for the inner link. This combination makes it a lube-free, low noise (5 dB lower than BS standard roller chain) and lightweight chain (50% lighter than BS standard roller chain). Working temperature range: -20°C to +80°C.

For details on corrosion resistance, please check out the table in the back of this catalogue.

BS SS Stainless Steel Chain

All basic components of this chain are made of Stainless Steel SUS304 equivalent (except the spring clips, which are made of SUS301). This chain can be used in special environments such as underwater, acidic and alkaline applications. It can also be used in high and low temperatures (-20°C to +400°C). SUS304 equivalent is only marginally magnetic, which is the result of the cold-forging process. For details on corrosion resistance, please check out the table in the back of this catalogue.

Corrosion Protected Chain (Carbon Steel base)

BS NEPTUNE™ Surface Treated Chain

BS NEPTUNE™ Chain is a TSUBAKI BS chain that has undergone a special surface treatment.

The link plates, bushes and bearing pins have a special three stage layer applied in order to provide the maximum protection from the operating or environmental conditions. (Spring clips are SUS301). NEPTUNE™ Rollers have a special coating designed to resist the corrosive conditions as well as the severe dynamic contact between roller and sprocket.

This chain is suitable for use in environments exposed to sea-water, acid-rain and other adverse weather conditions. This chain does not contain any chemically hazardous substances such as Hexavalent Chromium, Lead, Cadmium and Mercury as regulated by RoHS[√]. The kilowatt ratings are the same as those of the corresponding BS chain with a working temperature range: -10°C to +150°C. Above +60°C a special high-temperature lubrication is required. Of course, BS LAMBDA NEPTUNE™ chain is also available.

BS NP Nickel Plated Chain

BS NP Chain is a TSUBAKI BS chain that has been plated with Nickel. NP Chain has a light corrosion resistance and an attractive appearance. NP Chain is suitable for outdoor conditions exposed to water. There is a 15% reduction in Maximum Allowable Load compared to the corresponding BS chain, so please take this into account when making your chain selection. It has a working temperature range of: -10°C to +60°C. Of course, BS LAMBDA NP chain is also available.

[√] RoHS = Restriction of Hazardous Substances

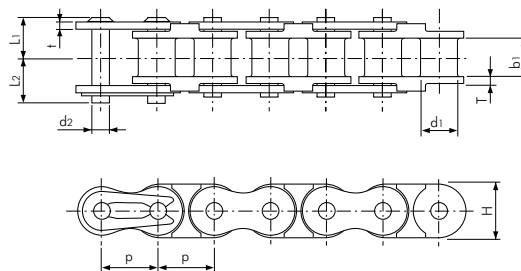

PC Chain

Dimensions in mm

TSUBAKI Chain No.	Pitch p	Bush Diameter d1	Inner Width b1	Pin			Link Plate			Max. Allowable load acc. to TSUBAKI kN	Approx. Mass kg/m
				Diameter d2	Length L1	Length L2	Thickness T	Thickness t	Height H (max)		
RF06B-PC-1	9.525 (3/8")	6.35	5.72	3.28	6.50	7.25	1.30	1.00	8.20	0.20	0.23
RS08B-PC-1	12.70 (1/2")	8.51	7.75	4.45	8.35	10.05	1.60	1.50	12.00	0.46	0.40
RS10B-PC-1	15.875 (5/8")	10.16	9.65	5.08	9.55	11.25	1.50	1.50	14.70	0.53	0.51
RS12B-PC-1	19.05 (3/4")	12.07	11.68	5.72	11.10	13.00	1.80	1.80	16.10	0.70	0.67

PC CHAIN

NEPTUNE™

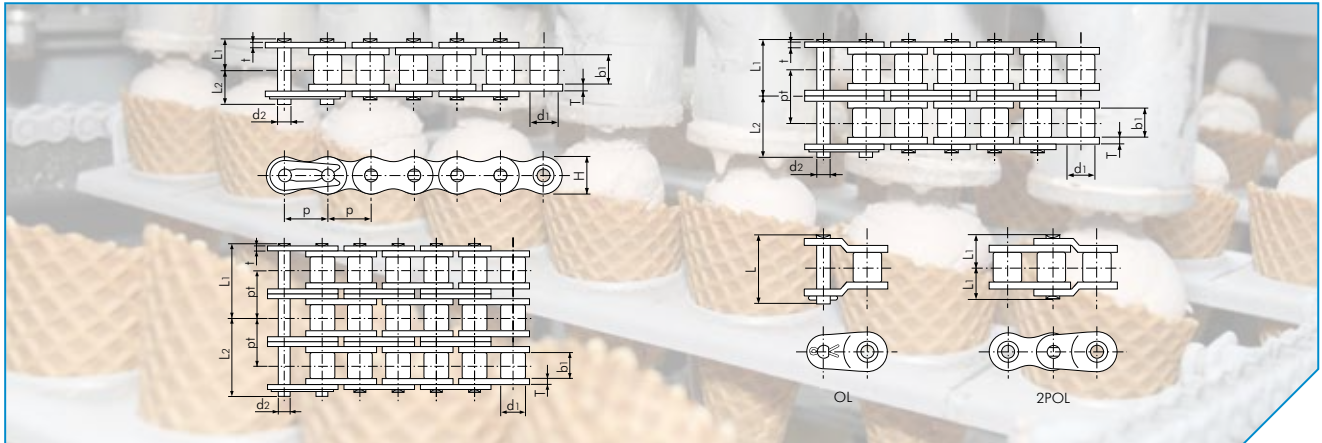

POWER TRANSMISSION

SS Chain

Dimensions in mm

TSUBAKI Chain No.	Pitch p	Roller Diameter d1	Inner Width b1	Pin			Link Plate			Transverse Pitch pt	Max. Allowable Load acc. to TSUBAKI kN	Approx. Mass kg/m	
				Diameter d2	Length L1	Length L2	Length L	Thickness T	Thickness t				Height H (max)
RF06B-SS-1	9.525 (3/8")	6.35	5.72	3.28	6.50	7.25	15.45	1.30	1.00	8.20	-	0.27	0.39
RF06B-SS-2					11.60	12.30	25.85				10.24	0.53	0.75
RS08B-SS-1	12.70 (1/2")	8.51	7.75	4.45	8.35	10.05	20.05	1.50	1.50	11.80	-	0.48	0.70
RS08B-SS-2					15.30	17.00	34.60				13.92	0.96	1.35
RS08B-SS-3					22.25	23.95	48.60				13.92	1.44	2.00
RS10B-SS-1	15.875 (5/8")	10.16	9.65	5.08	9.55	11.25	22.90	1.50	1.50	14.70	-	0.66	0.95
RS10B-SS-2					17.85	19.55	39.40				16.59	1.32	1.85
RS10B-SS-3					26.20	27.80	56.00				16.59	1.97	2.80
RS12B-SS-1	19.05 (3/4")	12.07	11.68	5.72	11.10	13.00	26.70	1.80	1.80	16.10	-	0.87	1.25
RS12B-SS-2					20.90	22.70	46.10				19.46	1.74	2.50
RS12B-SS-3					30.65	32.55	65.60				19.46	2.62	3.80
RS16B-SS-1	25.40 (1")	15.88	17.02	8.28	17.75	19.95	43.70	4.00	3.20	21.00	-	2.06	2.70
RS16B-SS-2					33.55	35.75	75.50				31.88	4.12	5.40
RS20B-SS-1	31.75 (1 1/4")	19.05	19.56	10.19	20.10	23.20	48.40	4.50	3.50	26.00	-	2.84	3.85

NEPTUNE™ Chain

Dimensions in mm

TSUBAKI Chain No.	Pitch p	Roller Diameter d1	Inner Width b1	Pin			Link Plate			Transverse Pitch pt	Min. Tensile Strength acc. to ISO 606 kN	Approx. Mass kg/m	
				Diameter d2	Length L1	Length L2	Length L	Thickness T	Thickness t				Height H (max)
RS08B-IM-NEP-1	12.70 (1/2")	8.51	7.75	4.45	8.40	10.00	18.60	1.60	1.60	11.80	-	17.8	0.70
RS08B-IM-NEP-2					15.30	16.90	34.50				13.92	31.1	1.35
RS10B-IM-NEP-1	15.875 (5/8")	10.16	9.65	5.08	9.55	11.25	20.80	1.50	1.50	14.70	-	22.2	0.95
RS10B-IM-NEP-2					17.85	19.55	39.40				16.59	44.5	1.85
RS12B-IM-NEP-1	19.05 (3/4")	12.07	11.68	5.72	11.10	13.00	24.40	1.80	1.80	16.10	-	28.9	1.25
RS12B-IM-NEP-2					20.85	22.75	45.90				19.46	57.8	2.50
RS16B-IM-NEP-1	25.40 (1")	15.88	17.02	8.28	17.75	19.95	41.10	4.00	3.20	21.00	-	60.0	2.70
RS16B-IM-NEP-2					33.55	35.75	75.20				31.88	106.0	5.40
RS20B-IM-NEP-1	31.75 (1 1/4")	19.05	19.56	10.19	19.90	23.10	46.60	4.40	3.40	26.40	-	95.0	3.85
RS24B-IM-NEP-1	38.10 (1 1/2")	25.40	25.40	14.63	26.65	31.85	61.70	6.00	5.60	33.40	-	160.0	7.45

CHAIN WITH ATTACHMENTS

In the world of attachment chain TSUBAKI is the manufacturer you require to assure smooth operation. Whether your application requires attachments or extended pins in Carbon Steel, Neptune™, Nickel Plating or Stainless Steel, TSUBAKI is your partner. TSUBAKI's maintenance free solution, LAMBDA, is also available with a wide range of attachments. When starting with a completely new design, TSUBAKI can tailor make an attachment chain for you in any specification.



GT4 WINNER WITH
BENT ATTACHMENTS



LAMBDA WITH
BENT ATTACHMENTS



NEPTUNE WITH
STRAIGHT ATTACHMENTS



PC WITH
EXTENDED PINS



LAMBDA FOR
CHOCOLATE MOULDING



NP/SS FOR
FILM GRIPPING

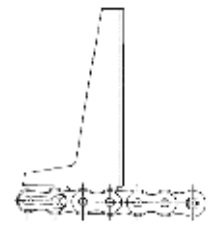

LAMBDA FOR
CARTONING

MATCH & TAG

When even more accurate tolerances are required, TSUBAKI can offer an effective solution with the Match & Tag Service. This can be useful for attachment chains which have to run parallel in pairs and where a minimum of chain length tolerance is required.

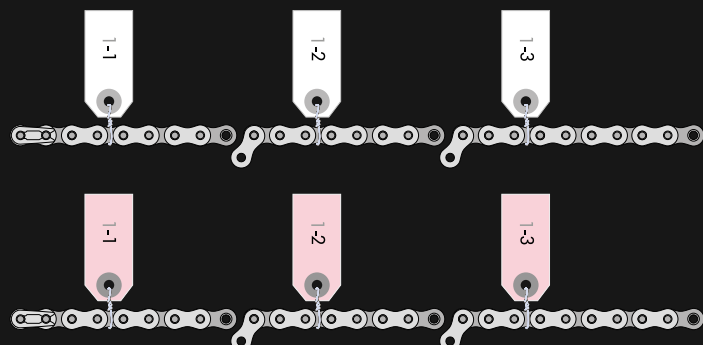

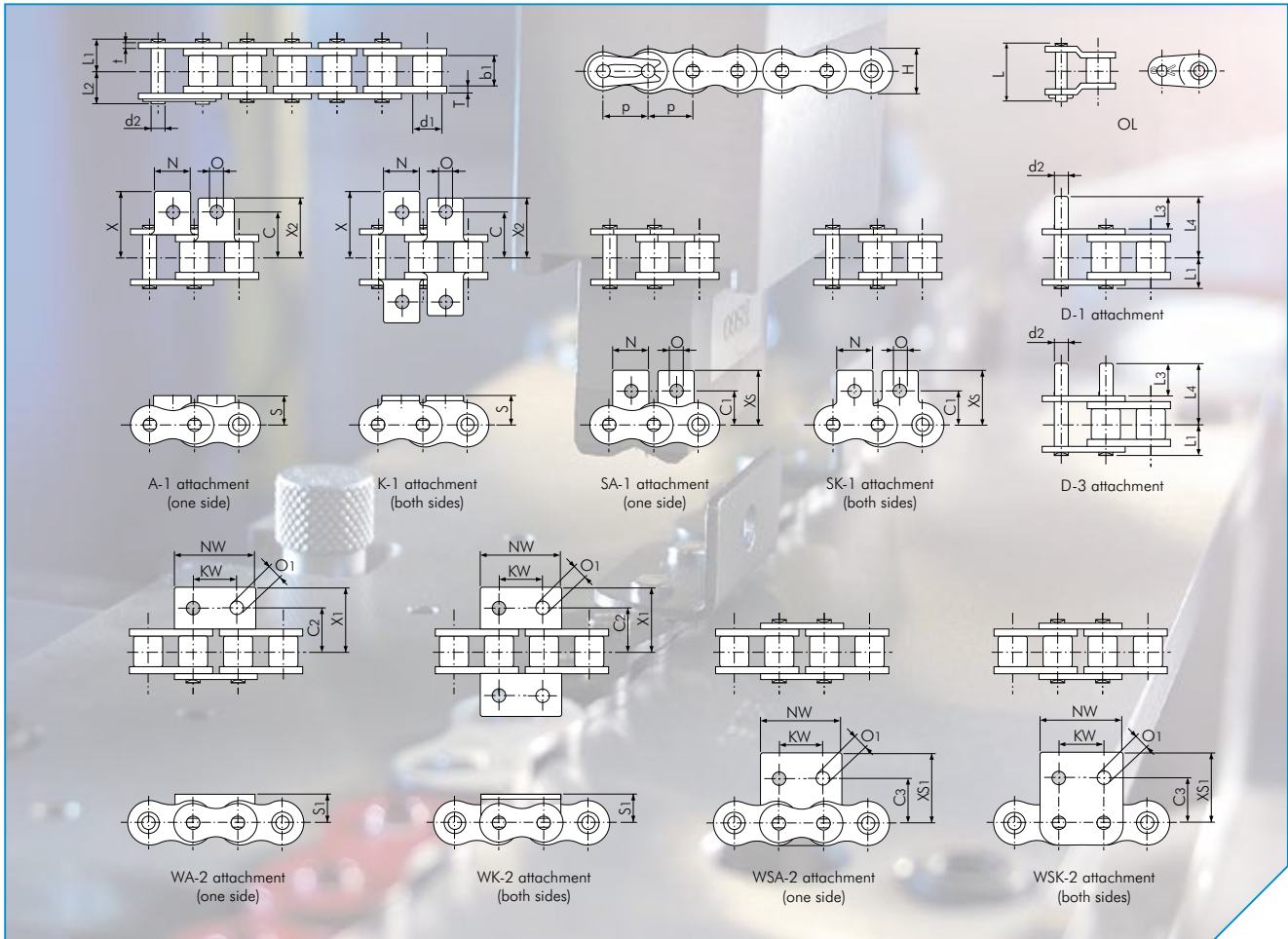

Single Pitch Standard Chain

Dimensions in mm

TSUBAKI Chain No.	Pitch p	Roller Diameter d1	Inner Width b1	Pin						Link Plate			Approx. Mass kg/m
				Diameter d2	Length L1	Length L2	Length L3	Length L4	Length L	Thickness T	Thickness t	Height H (max.)	
RF06B	9.525 (3/8")	6.35	5.72	3.27	6.10	7.70	10.90	16.30	15.10	1.30	1.00	8.20	0.39
RS08B	12.70 (1/2")	8.51	7.75	4.45	8.40	10.00	14.70	22.20	18.60	1.60	1.60	11.80	0.70
RS10B	15.875 (5/8")	10.16	9.65	5.08	9.55	11.25	17.80	26.15	20.80	1.50	1.50	14.70	0.95
RS12B	19.05 (3/4")	12.07	11.68	5.72	11.10	13.00	20.80	30.60	24.40	1.80	1.80	16.10	1.25
RS16B	25.40 (1")	15.88	17.02	8.28	17.75	19.95	33.20	49.35	41.10	4.00	3.20	21.00	2.70
RS20B	31.75 (1 1/4")	19.05	19.56	10.19	19.90	23.10	38.40	56.90	46.60	4.40	3.40	26.00	3.85

TSUBAKI Chain No.	Attachment Dimensions															Attachment Mass						
	C	C1	C2	C3	KW	N	NW	O	O1	S	S1	X	X1	X2	XS	XS1	A SA	K SK	WA WSA	WK WSK	Ext. Pin	
RF06B	9.50	9.50	-	-	-	8.50	-	3.50	-	6.5	-	14.10	-	-	14.30	-	0.002	0.004	-	-	-	0.001
RS08B	11.90	12.70	12.70	13.10	12.70	11.40	24.60	4.20	4.90	8.90	8.90	19.05	20.30	17.15	19.30	20.70	0.002	0.004	0.005	0.010	0.001	0.001
RS10B	15.90	15.90	15.90	16.60	15.90	12.70	30.00	5.00	5.00	10.20	10.20	22.25	22.85	20.60	22.90	23.60	0.003	0.006	0.006	0.012	0.002	0.002
RS12B	19.05	22.20	17.45	17.60	19.10	16.50	34.80	7.10	5.50	13.50	11.40	29.85	25.65	27.80	32.05	25.75	0.006	0.012	0.009	0.018	0.003	0.003
RS16B	23.80	23.90	28.60	26.00	25.40	24.30	46.00	6.70	8.10	15.20	15.90	37.35	39.25	34.40	34.10	36.70	0.014	0.028	0.030	0.060	0.008	0.008
RS20B	31.75	31.80	-	-	-	25.40	-	8.70	-	19.80	-	44.85	-	-	44.00	-	0.027	0.054	-	-	-	0.014

Note:
1. RF06B chain has flat-shaped link plates.

TSUBAKI SPROCKET SOLUTIONS

TSUBAKI now offers a big range of high quality sprockets. Our sprockets are built from top-grade, heat-treated carbon steel to offer long wear life, resist abrasion, and withstand heavy shock loads. You get longer service life and reliable performance, turn after turn, time after time.

For extra corrosion resistance and food-grade applications, alloy and stainless steel sprockets are also available.

Sprocket Performance

System performance highly depends on chain-sprocket interaction, which means your choice of sprockets can elevate your operation's success. Make the right and easy choice with sprockets from TSUBAKI.

- Reduced downtime maintenance
- Increased productivity
- Lower replacement costs

Stock Line Up

In order to serve the majority of the sprocket market, Tsubakimoto Europe has stocked a vast range of sprockets.

- Carbon Steel sprockets acc. DIN 8187 standard (Simplex & Duplex)
- Stainless Steel sprockets acc. DIN 8187 standard (Simplex)
- Carbon Steel sprockets acc. ANSI standard (Simplex)
- Carbon Steel Taper Bore sprockets acc. DIN 8187 standard (Simplex)
- Taper Bushes, metric series

To ensure maximum performance of your drive system, TSUBAKI carbon steel sprockets are executed with induction hardened teeth as a standard to make a perfect match with the high quality TSUBAKI chains.

Special Sprockets

To enjoy the advantage of the availability of customized sprockets according to customer drawings, special agreements can be made to have stock available in our warehouse. This way you are able to reduce your stock and increase delivery performance as well as production efficiency. Please contact our Sales Department for further details.



“We offer a complete line of standard and customized sprockets!”

Design Features

TSUBAKI has selected specific design features to realize the maximum performance from your power transmission as well as your logistics handling system:

Hardened Teeth

All stocked carbon steel sprockets are executed with induction hardened teeth to achieve maximum wear life of both sprockets and chain.

Hardness range: 40 - 55 HRC

Hardness depth: 0,5 - 1,5 mm

Materials

Our sprocket range is available from stock in high quality steels:

Carbon steel (single piece type: C45, welded hub type: C20/Q235)

Stainless steel (AISI 304)

TSUBAKI Box

To help you reduce your handling cost, all TSUBAKI sprockets are packed in TSUBAKI boxes. Boxed packaging make the handling and storage of sprockets more efficient.

Each carbon steel sprocket is protected with a layer of rust preventive oil and is wrapped in a plastic cover inside the TSUBAKI box.

Bar Coding

Besides the use of a TSUBAKI box, also bar coding is applied reducing your handling cost even more.

MADE TO ORDER SPROCKETS



TSUBAKI has designed and manufactured made-to-order (MTO) sprockets since more than 60 years.



Extensive design, engineering and manufacturing capabilities allow TSUBAKI to produce a wide variety of MTO sprocket products for a multitude of applications. Our capabilities include CNC machining for special tooth profiles, in-house heat

treatment and a variety of product finishes. Our CAD design capabilities allow us to provide highly customized solutions for almost every application.

POWER TRANSMISSION

Wear Indicator

TSUBAKI Sprocket Wear Indicator Technology assures maximum uptime and drive system efficiency by providing visual confirmation of excessive sprocket wear. Incorporating this patented technology into MTO, ANSI, or Engineering Class sprockets reduces overall system cost by offering predictable maintenance intervals to avoid catastrophic failure.

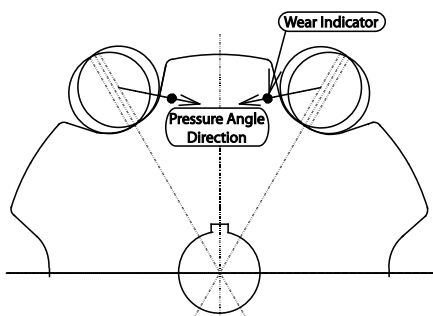

Segmental rim and hubs

Segmental rims are designed to save time and money by reducing costly downtime. The rims can be replaced without having to remove shaft and bearings.

CAM CLUTCH - FREEWHEEL

TSUBAKI offers the most complete and versatile selection of one-way clutches in the global industry. Cam Clutches are precision devices which lock the inner- and outer races, through a wedging action of cams, to transmit torque in one direction of rotation and overrun in the opposite direction. These units are often referred to as freewheels, sprag clutches, overrunning clutches, backstops or one-way clutches, depending upon on the application for which they are used.

Design Features

Full Cam Complement

The full complement of cams provides the maximum number of load transmitting members per given diameter. The result is a higher torque capacity than other clutches.

Cam Design

Precision formed cams, made of special alloy steel assure extra long wear- and fatigue life.

High Quality Components

Outer- and inner races are made of high-quality alloy steel with high surface hardness and core toughness. The races are precision ground, providing excellent concentricity and surface finish to obtain accurate cam rotation.

BB, BB1K, BB2K SERIES

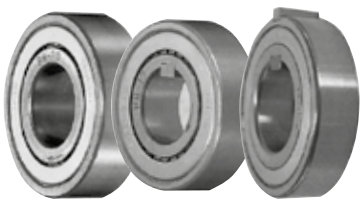

BB Series Cam Clutch Freewheels with shields have bearing characteristics and dimensions of type 62 ball bearings. Press fit, single inner race keywayed (1K) and inner and outer race keywayed (2K) versions available. Keys for inner and outer race also available.

Bore sizes - 15, 17, 20, 25, 30, 35, 40mm
Maximum torque - 260Nm

BR-HT SERIES



BR-HT centrifugal lift off Cam Clutch series Backstops are designed for high speed backstopping operations with higher torque requirements. The BR-HT Series is an open type design for directly into machinery such as gear reducers, pumps and winches.

41 Clutch sizes
Bore range - 20-320mm
Maximum torque - 366000Nm

BSEU / BSEU 2GD SERIES



BSEU Series are pre-lubricated European style Cam Clutches designed primarily for backstopping operations. The BSEU has an integral torque arm on the outer race and is fitted with high performance V-ring seals. The BSEU Series is fitted TSUBAKI's unique self- lubricating cam/roller mechanism for longer life. The BSEU 2GD Series is fitted with a lip seal and outer cover for enhanced dust and spray protection.

4 Clutch sizes
Bore sizes - 20, 25, 30, 35, 40, 45, 50, 55, 60, 65, 70, 75, 80, 90mm
Maximum torque - 4700Nm

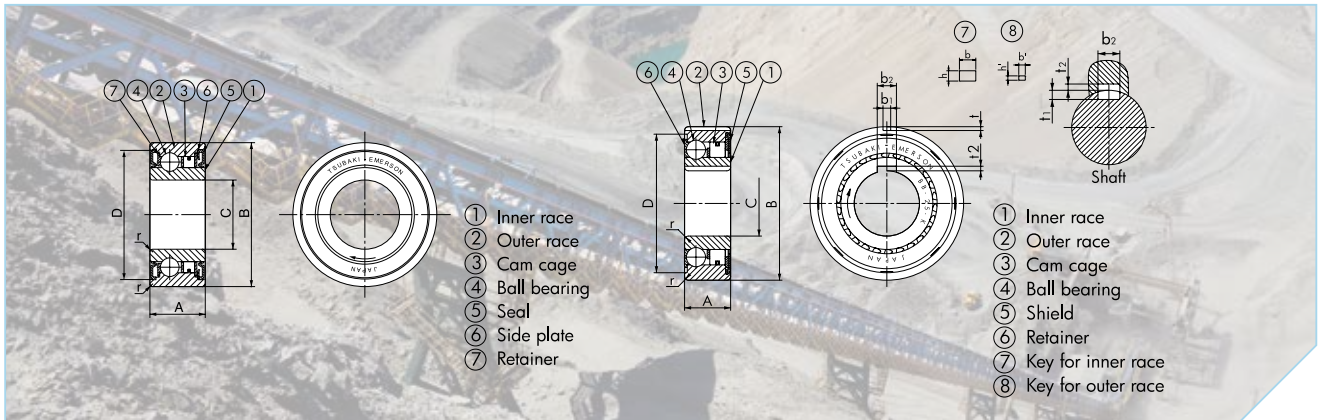

BB, BB-1K-K, BB-2K-K, BB-2GD, BB-2GD 1K-K

Dimensions in mm

Model	Torque Capacity Nm	Max. Overrunning Speed		Drag Torque Nm		A		B	C	D		r	Bearing Loads		Approx. Mass g/pc	
		Inner Race r/min	Outer Race r/min	BB BB-1K-K BB-2K-K	BB-2GD BB-2GD 1K-K	BB BB-1K-K BB-2K-K	BB-2GD BB-2GD 1K-K			BB BB-1K-K BB-2K-K	BB-2GD BB-2GD 1K-K		C	C ₀	BB BB-1K-K BB-2K-K	BB-2GD BB-2GD 1K-K
BB15	29	3600	2000	0.010	0.040	11	16	35	15	32.6	32.45	0.6	5950	3230	50	70
BB17	43	3500	1900	0.010	0.050	12	17	40	17	36.1	36.45	0.6	7000	3700	80	100
BB20	61	3000	1600	0.014	0.055	14	19	47	20	41.7	42.35	1.0	8500	4900	120	150
BB25	78	2500	1400	0.017	0.055	15	20	52	25	47.1	47.05	1.0	10700	6300	150	200
BB30	140	2000	1100	0.030	0.058	16	21	62	30	56.6	55.60	1.0	11900	7900	230	280
BB35	173	1800	1000	0.034	0.060	17	22	72	35	64.0	64.60	1.1	13500	9700	320	410
BB40	260	1800	900	0.040	0.080	22	27	80	40	71.0	71.60	1.1	14500	11700	400	600

Model	Shaft Diameter	Housing Diameter	Model	Shaft Diameter	Housing Diameter	Model	Shaft Diameter	Housing Diameter		
BB15	BB15-2GD	15 +0.023 +0.012	35 -0.012 -0.028	BB15-1KK	BB15-2GD 1KK	15 -0.008 -0.028	35 -0.012 -0.028	BB15-2KK	15 -0.008 -0.028	35 -0.002 -0.018
BB17	BB17-2GD	17 +0.023 +0.012	40 -0.012 -0.028	BB17-1KK	BB17-2GD 1KK	17 -0.008 -0.028	40 -0.012 -0.028	BB17-2KK	17 -0.008 -0.028	40 -0.002 -0.018
BB20	BB20-2GD	20 +0.028 +0.015	47 -0.012 -0.028	BB20-1KK	BB20-2GD 1KK	20 -0.010 -0.031	47 -0.012 -0.028	BB20-2KK	20 -0.010 -0.031	47 -0.003 -0.022
BB25	BB25-2GD	25 +0.028 +0.015	52 -0.014 -0.033	BB25-1KK	BB25-2GD 1KK	25 -0.010 -0.031	52 -0.014 0.033	BB25-2KK	25 -0.010 -0.031	52 -0.003 -0.022
BB30	BB30-2GD	30 +0.028 +0.015	62 -0.014 -0.033	BB30-1KK	BB30-2GD 1KK	30 -0.010 -0.031	62 -0.014 -0.033	BB30-2KK	30 -0.010 -0.031	62 -0.003 -0.022
BB35	BB35-2GD	35 +0.033 +0.017	72 -0.014 -0.033	BB35-1KK	BB35-2GD 1KK	35 -0.012 -0.037	72 -0.014 -0.033	BB35-2KK	35 -0.012 -0.037	72 -0.006 -0.025
BB40	BB40-2GD	40 +0.033 +0.017	80 -0.014 -0.033	BB40-1KK	BB40-2GD 1KK	40 -0.012 -0.037	80 -0.014 -0.033	BB40-2KK	40 -0.012 -0.037	80 -0.006 -0.025

Model	Keyway	Inner Race Key		Outer Race Key	
		b x h x length	b' x h' x length		
BB15-1KK	BB15-2GD 1KK	5.0	1.9	1.2	-
BB15-2KK	-	5.0	1.9	1.2	2.0
BB17-1KK	BB17-2GD 1KK	5.0	1.9	1.2	2.0
BB17-2KK	-	5.0	1.9	1.2	2.0
BB20-1KK	BB20-2GD 1KK	6.0	2.5	1.6	3.0
BB20-2KK	-	6.0	2.5	1.6	3.0
BB25-1KK	BB25-2GD 1KK	8.0	3.6	1.5	6.0
BB25-2KK	-	8.0	3.6	1.5	6.0
BB30-1KK	BB30-2GD 1KK	8.0	3.1	2.0	6.0
BB30-2KK	-	8.0	3.1	2.0	6.0
BB35-1KK	BB35-2GD 1KK	10.0	3.7	2.4	8.0
BB35-2KK	-	10.0	3.7	2.4	8.0
BB40-1KK	BB40-2GD 1KK	12.0	5.0	3.3	10.0
BB40-2KK	-	12.0	5.0	3.3	10.0

Note:

For BB25-1KK, BB25-2KK and BB25-2GD 1KK the dimension of t₂ is 0.5 mm shallower than DIN 6885.3. To use a DIN standard key, process the keyway 0.5 mm deeper on the shaft than according to DIN standard. All other models are dimensionally interchangeable.

TSUBAKI CHAIN WEAR INDICATOR



CONTENT



BS Set

(Art. no. 2017031680)

- Chain Wear Indicator in sizes RFO6B to RS16B
- Chain Identifier for BS & ANSI chain
- Instructions on how to use

ANSI Set

(Art. no. 2017031681)

- Chain Wear Indicator in sizes RS35 to RS80
- Chain Identifier for BS & ANSI chain
- Instructions on how to use



BS Large Size Indicator

- Available in sizes RS20B to RS56B
- Each size sold separately in leatherette pouch

ANSI Large Size Indicator

- Available in sizes RS100 to RS240
- Each size sold separately in leatherette pouch

MEASURE WEAR

The TSUBAKI Chain Wear Indicator is designed to measure roller chain condition and determine critical wear. The gauges are made of quality material and are resistant to corrosion. Their robust construction ensures accurate measuring everytime.

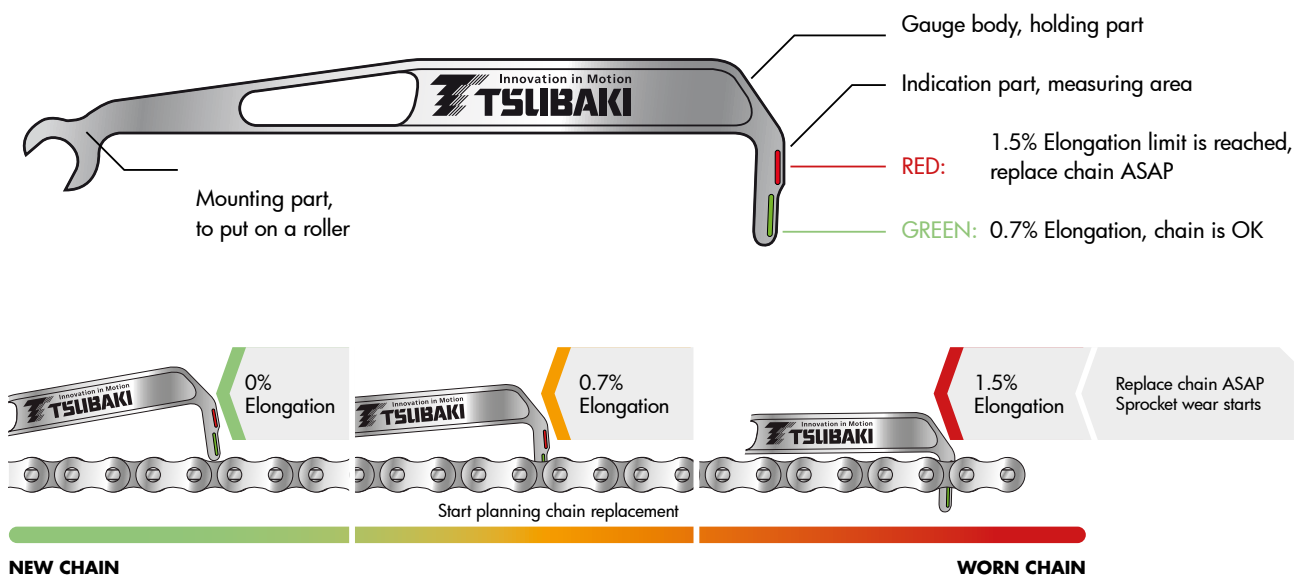

TSUBAKI RECOMMENDATION:

- Use the Chain Wear Indicator according to your regular maintenance schedule of the machine or production line.
- Always measure on several points - do not be satisfied with one measurement, since the chain might wear unevenly.
- Regularly checking the chain for wear allows for better management of maintenance scheduling and eliminates the risk of chain breakage.
- Replacing chains before reaching 1.5% elongation will prevent significant sprocket wear, thus averting costly downtime.

For more information, please visit www.tsubaki.eu



Power Transmission Solutions

Roller Chains from Cross+Morse

POWER TRANSMISSION

Standard Chains



Cross+Morse produce only high-performance roller chain of consistent quality as an ISO 9001:2015 company, using modern manufacturing technology combined with long established proven specifications to give long service life.

- **B.S. 3/8" to 2.1/2" pitch chains, simplex, duplex & triplex. ANSI 25 to 200.**
- **Straight sideplate simplex & duplex, Hollow pin chain, Double pitch BS chain.**
- **Short delivery lead times, free chain cutting service.**
- **Easy disassembly as pins produced using a copper plating process on BS chain 1/2" and over.**

Special Attachment Chains



K and M plates and extended pins

We have a large range of attachments for standard roller chains, including 304 stainless steel chain components.

- **Standard K1, K2 and M1, M2 plates manufactured**
- **Extended pins manufactured on site**
- **Matched lengths stress tested**

Roller Chains from Cross+Morse



Power Transmission Solutions

Chain with special attachments

Cross+Morse chain systems are supplied to the food, packaging and processing industries as it provides unfailing operation throughout lengthy production cycles, 24 hours a day. Suitable for new or retrofit installation.

Custom designed attachments manufactured, both as individual components and as chain assemblies

- **Suitable for the food, drink and packaging sectors**
- **In feed, cross feed, powerbend and side guide chains supplied**
- **Chocolate moulding chain with special attachments**



Inverted Tooth Chains

Inverted tooth chains provide a concept for the transmission of high torque combined with high shaft speeds, resulting in smooth running and quiet drives transmitting up to 4,000 kW with shaft speed to 12,000 rpm.

- **HC Hy-Vo 63-139 – 3/8" to 1"**
- **HC Hy-Vo 61-115 – 1.1/2 to 2"**
- **SC Series Inverted Tooth Chains 3/16" to 2" pitch**
- **HC + SC Sprockets manufactured in house to suit chain**





Power Transmission Solutions

Roller Chains from Cross+Morse

Stainless Steel & Corrosion Resistant Roller Chains

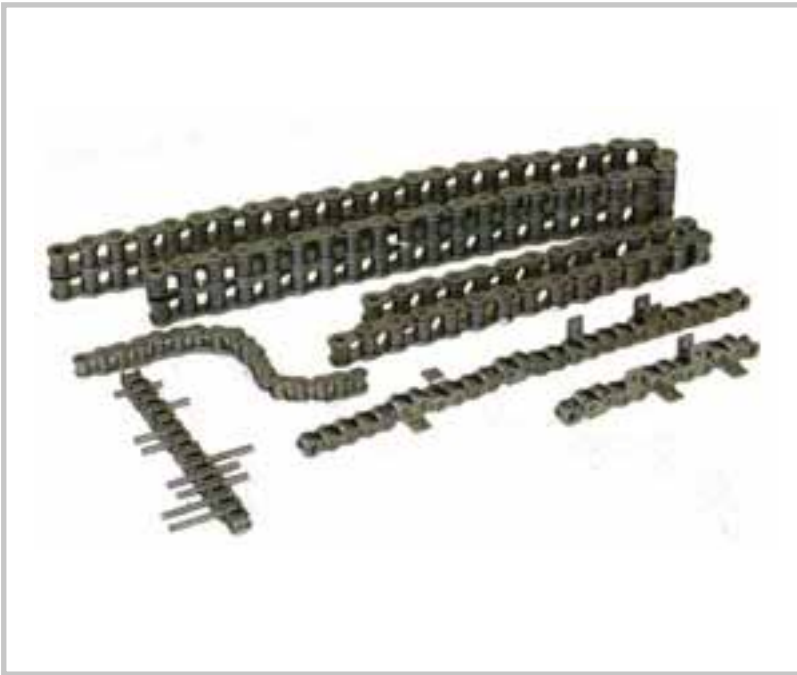

Standard stainless steel chains are manufactured in both 304 and 316 grade steels for high corrosion resistance. Especially suited to environments where water, acids, chemicals, high humidity and extremes of temperature are encountered.

- **B.S. 6mm to 1¼" pitch simplex & duplex - SS304**
- **B.S. 8mm to 1" pitch simplex – SS316**
- **ANSI standard from ¼" to 1" in simplex**
- **Simplex chains also available Nickel plated or Aquaproofed**

Cross+Morse Overload Protection



Power Transmission Solutions

Torque Limiters

POWER
TRANSMISSION

Morse Torque Limiter is a protection device that limits torque transmitted in a drive, by slipping when the torque exceeds a preset value, due to shock loads, overloads, or machine jams. It automatically re-engages when the overload has passed.

- **Simple Design • Easy Adjustment • Wide Torque Adjustment • Compact**
- **Minimum Maintenance • Economical • Dependable**
- **Stocked in both pilot bore and pre-bored to popular sizes to give prompt delivery**
- **Manufactured by Cross+Morse in Birmingham, England**



Cross Sheargard Clutch

Cross Sheargard Clutch uses a unique shaped wedge pin to provide overload protection. Designed to accept standard torque limiter platewheels and roller chain couplings.

- **Sheargard clutches provide a torque range from 27 to 16,700Nm, larger standard units made to order with torque capacities up to 69,700Nm**
- **Optional sensor plate to trigger a limit switch to isolate the drive**
- **Wedge pins are available in both steel and brass.**
- **Brass wedge pin generates no spark when broken.**





Power Transmission Solutions

Cross+Morse Overload Protection

POWER
TRANSMISSION

Crossgard



Crossgard series of overload clutches use random positioned sprung loaded balls locked in detents to provide drive and overload control. 3 types are offered, all with optional Flexible Shaft Couplings

- **Type CG - Low cost, simple design for general purpose applications: torque range (10-7154Nm) with operating speeds up to 700 rpm.**
- **Type CGX - Unique design provides zero backlash drives; torque range 1.7-785Nm and maximum speed 1,400 rpm**
- **Type CGZ - High speed (up to 1800 rpm) overload clutch, with total drive disengagement: torque range 2.4-450Nm**

Safeguard Overload Clutches



Safeguard overload clutches are designed to be fully interchangeable with other European manufacturers. Using a number of balls on unsynchronized units, and random positioned rollers on synchronized units, enables high torques and operating speeds to be achieved.

- **Units available are CSF, CSY, CSL, CSZ, CZF, CZY,**
- **Synchronous & non-synchronous design available**
- **Zero backlash on some units**
- **CZP – Pneumatically operated to enable torque**
- **Adjustment whilst machine is running**

Roller Chain Couplings from Cross+Morse



Power Transmission Solutions

LRC Duplex Roller Chain Couplings

Cross & Morse Roller Chain Couplings consist of three high strength components; two special chain sprockets manufactured from high quality medium carbon alloy steels connected by a length of high strength Duplex Roller Chain.

- **Sprockets have precision cut teeth, induction hardened for maximum service life**
- **Available either plain bore or machined for taper bores**
- **Low to medium speed drives (to 2,000rpm)**



LNC DELRIN® Chain Couplings

Morse Delrin® Chain Couplings for Applications up to 5000 rpm and from fractional to 45Kw. Available in two series N400 ½" pitch & N600 ¾" pitch.

- **Medium speed drives (to 5,000 rpm)**
- **Corrosion proof chain**
- **Suitable for textile and food processing machines**
- **Available with minimum plain bore, finished bore with standard keyway and setscrew, or taper bore**



Delrin® is a registered trademark of DuPont



Power Transmission Solutions

Cross+Morse Sprockets, Gears, Specials & Rework

POWER TRANSMISSION

Sprockets & Platewheels



Cross+Morse carry an extensive stock range of low cost pilot bored Sprockets (simplex, duplex and triplex) and Platewheels to suit B.S. simplex and multi-strand chains.

- **B.S. simplex and multi-strand chains from 6mm to 2" pitch**
- **ANSI simplex from 3/8" to 1 1/2" pitch,**
- **Double simplex sprockets 12 to 25 teeth, for 3/8" to 1" pitch British Standard chain available pilot/ taper bore.**
- **All available with hardened teeth, pilot bore or finished bored with keyway and set-screw**

Taper Bore Steel Sprockets



Stock range of taper bore steel Sprockets in most tooth sizes from 13 up to 114 teeth, and cast iron in popular tooth sizes from 38 up to 114 teeth; for British Standard simplex, duplex, and triplex chains from 3/8" to 1 1/2" pitch.

Steel taper bore sprockets are suitable for induction hardening.

Cross+Morse Sprockets, Gears, Specials & Rework



Power Transmission Solutions

Crossbore®

POWER
TRANSMISSION

Dedicated production area with specialized CNC machines provides a rapid response rework service of standard. Known as Crossbore®; this service includes re boring, keywaying, setscrewing, blacking, marking and induction hardening.

- **Sprockets, pulleys and gears**
- **Torque Limiters, Crossgard, Safeguard and Sheargard Clutches**
- **Jaw, Gear and Chain Couplings**
- **Tolerance of H7, M7 or F7**



Special Manufacturing

Cross+Morse has an extensive manufacturing capability at our factory in Birmingham and have the ability to produce custom designed sprockets, platewheels, pulleys, spur gears, helical gears, split wheels and ring-gears.

- **Turn, Gearcut, Drill, Tap, Mill, Keyway, Broach, Slot.**
- **Grind, Induction Harden and Blacking.**





Power Transmission Solutions

Cross+Morse Sprockets, Gears, Specials & Rework

POWER
TRANSMISSION

Special Bevel and Mitre Gears



Straight cut bevel and mitre gears with pitch up to 10Mod, and diameter up to 500mm, can be manufactured on short lead times in a variety of materials to suit customer requirements.

- **Standard stock of over 400 different sizes**
- **Manufactured to the Gleason system**
- **Gears can be induction hardened**

Racks & Gears



Racks are available for standard pitches from 1Mod to 8Mod, in 4 stock lengths of 0.5, 1.0, 2.0 and 3.0 metres. Alternate lengths can be supplied to order.

- **Racks can be machined to suit your application.**
- **Spur gears from 1Mod up to 8Mod pitch, with tooth sizes from 12 to 127 teeth.**
- **Gears can be induction hardened to enhance wear life.**

RENOLD



- Our leading standard steel transmission chain
- Excellent wear resistance
- Wide waisted GP plate shape
- Fatigue performance rated as ISO + 60%
- Guarantee of 15,000 hours
- End-softened, spin riveted pin for easy cutting
- 3/8" to 4" pitch, simplex & duplex

Renold's unique control over pin / bush contact makes sure that wear life exceeds other brands. Little initial chain adjustment is therefore required. Renold roller chain is highly fatigue resistant, giving up to four times the life of other leading competitor chains.

Breaking loads exceed the minimum requirements of the international standards.

Renold's end-softened pin and spin rivet help to minimise downtime. All you need is a Renold pin extractor

and you can disassemble Renold roller chain in seconds; no need to grind the head of the pin, no need for lengthy downtime.

Simplex

Renold BS Order Code	ISO No.	Pitch inch	Connecting links					
			4	107	11	26	12	30
SD06B1X10FT	06B-1	0.375	✓	✓	-	✓	-	✓
SD08B1X10FT	08B-1	0.500	✓	✓	-	✓	-	✓
SD10B1X10FT	10B-1	0.625	✓	✓	-	✓	-	✓
SD12B1X10FT	12B-1	0.750	✓	✓	-	✓	-	✓
SD16B1X10FT	16B-1	1.000	✓	✓	-	✓	✓	✓
SD20B1X10FT	20B-1	1.250	✓	✓	-	✓	✓	✓
SD24B1X10FT	24B-1	1.500	✓	✓	✓	-	✓	✓

Duplex

Renold BS Order Code	ISO No.	Pitch inch	Connecting links					
			4	107	11	26	12	30
SD06B2X10FT	06B-2	0.375	✓	✓	-	✓	-	✓
SD08B2X10FT	08B-2	0.500	✓	✓	-	✓	-	✓
SD10B2X10FT	10B-2	0.625	✓	✓	-	✓	-	✓
SD12B2X10FT	12B-2	0.750	✓	✓	-	✓	-	✓
SD16B2X10FT	16B-2	1.000	✓	✓	-	✓	✓	✓
SD20B2X10FT	20B-2	1.250	✓	✓	-	✓	✓	✓
SD24B2X10FT	24B-2	1.500	✓	✓	✓	-	✓	✓



S11/S58



S26



S107

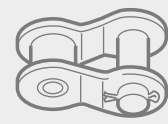

S12



S30

RENOLD Syno™



- No lubrication normally required
- Outside of chain totally dry-to-the-touch
- Nickel-plated plates
- Food industry-approved lubricant within sintered bush
- Unique food industry-approved roller coating
- Dimensionally interchangeable with standard chain
- ISO standard pin diameter, therefore standard attachments on outer links

For use in hygiene-sensitive applications or situations where contamination from lubricant is to be avoided, Renold Syno chain displays all the characteristics you need from a chain. With a food industry-approved lubricant within the sintered bush, this chain will in almost all instances not need relubricating. The roller coating is also suitable for use in the food industry; a unique feature on any chain.

Available in boxed 10-foot lengths from 06B to 24B and ANSI 40 to ANSI 100, simplex and duplex with a standard pin diameter, this means that Renold Syno chain is dimensionally interchangeable with standard roller chain and is even compatible with standard sprockets.

With the kind of excellent wear and fatigue resistance that you expect from a Renold chain, Syno chain outlasts any competitor

product promoted as low-lube or non-lube. Already tried and tested by major companies in the food sector and elsewhere, if you have to operate with minimal lubrication but can't compromise on performance, we can boost your productivity, cut your downtime and save you time and money.

Simplex

Renold BS Order Code	ISO No.	Pitch inch	Connecting links				
			26	107	11	12	30
06B1SNX10FT	06B-1	0.375	✓	✓	-	-	✓
08B1SNX10FT	08B-1	0.500	✓	✓	✓	-	✓
10B1SNX10FT	10B-1	0.625	✓	✓	✓	-	✓
12B1SNX10FT	12B-1	0.750	✓	✓	✓	-	✓
16B1SNX10FT	16B-1	1.000	✓	✓	✓	✓	✓
20B1SNX10FT	20B-1	1.250	✓	✓	✓	✓	✓
24B1SNX10FT	24B-1	1.500	-	✓	✓	✓	✓

Duplex

Renold BS Order Code	ISO No.	Pitch inch	Connecting links				
			26	107	11	12	30
06B2SNX10FT	06B-2	0.375	✓	✓	✓	-	✓
08B2SNX10FT	08B-2	0.500	✓	✓	✓	-	✓
10B2SNX10FT	10B-2	0.625	✓	✓	✓	-	✓
12B2SNX10FT	12B-2	0.750	✓	✓	✓	-	✓
16B2SNX10FT	16B-2	1.000	✓	✓	-	✓	✓
20B2SNX10FT	20B-2	1.250	✓	✓	✓	✓	✓
24B2SNX10FT	24B-2	1.500	-	✓	✓	✓	✓



S11/S58



S26



S107

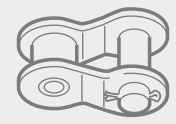

S12



S30

Renold Hydro-Service®

Superior corrosion resistance for chain



- Superior corrosion resistance
- Last as much as 30 times longer than standard carbon steel
- Hexavalent chrome free
- 350 hours corrosion protection during salt spray tests to DIN 50021
- Cold extruded, solid bush and roller delivering maximum Renold performance
- Plates and rollers shot peened to our exact specifications
- Wear and fatigue resistance that delivers maximum working life
- Lubrication that improves wear performance

Renold Hydro-Service chain delivers superior corrosion resistance, lasting as much as 30 times longer than standard carbon steel in applications that have to deal with water or salt spray. It is ideal for wash-down environments.

Hydro-Service chain is also more economical, and stronger, than stainless steel.

Each component is mechanically treated prior to assembly to ensure consistent, secure protection. The

surface treatment is free of hexavalent chrome, complying with legislation relating to environmental and health & safety considerations.

Simplex

Renold BS Order Code	ISO No.	Pitch inch	Connecting links				
			26	107	11	12	30
06B1HSX10FT	06B-1	0.375	✓	✓	-	-	✓
08B1HSX10FT	08B-1	0.500	✓	✓	-	-	✓
10B1HSX10FT	10B-1	0.625	✓	✓	-	-	✓
12B1HSX10FT	12B-1	0.750	✓	✓	-	-	✓
16B1HSX10FT	16B-1	1.000	✓	✓	-	✓	-
20B1HSX10FT	20B-1	1.250	✓	✓	-	✓	-
24B1HSX10FT	24B-1	1.500	-	✓	✓	✓	-

Duplex

Renold BS Order Code	ISO No.	Pitch inch	Connecting links				
			26	107	11	12	30
06B2HSX10FT	06B-2	0.375	✓	✓	-	-	✓
08B2HSX10FT	08B-2	0.500	✓	✓	-	-	✓
10B2HSX10FT	10B-2	0.625	✓	✓	-	-	✓
12B2HSX10FT	12B-2	0.750	✓	✓	-	-	✓
16B2HSX10FT	16B-2	1.000	✓	✓	-	✓	-
20B2HSX10FT	20B-2	1.250	✓	✓	-	✓	-
24B2HSX10FT	24B-2	1.500	-	✓	✓	✓	-



S11/S58



S26



S107

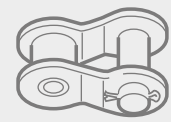

S12



S30

Renold Conveyor Chain

Standard stock range of BS conveyor chain, available ex-stock. 3,000 to 30,000lb chains produced in our dedicated UK manufacturing cell.



- Fast availability of standard integral attachments
- Standard cast iron sprockets available ex-stock
- Supporting this standard range we also have the capability to supply specials and custom-designed products.

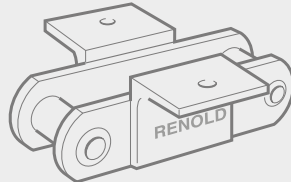
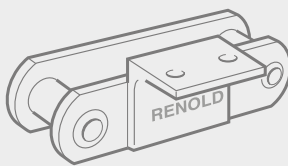
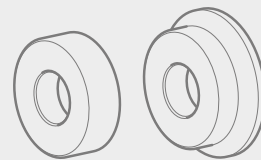
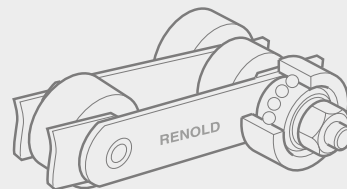
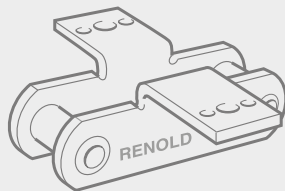
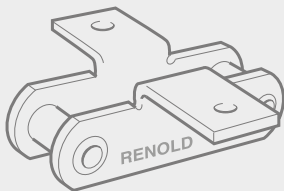

RENOLD SD



- An extensive product line of European (BS), ANSI and DIN standard chains
- Competitive prices and delivery
- Consistent quality
- Depth of inventory

If you are looking for a good quality product from a reliable supplier for “standard duty” chain applications, look to **RENOLD SD**, the new benchmark in the economy chain category.

Renold is recognized as the worldwide leader in chain products and has established manufacturing facilities across the globe.

While most suppliers buy-in their economy line of chain, Renold manufactures its own.

Simplex

Renold BS Order Code	ISO No.	Pitch inch	Connecting links					
			4	107	11	26	12	30
SD06B1X10FT	06B-1	0.375	✓	✓	-	✓	-	✓
SD08B1X10FT	08B-1	0.500	✓	✓	-	✓	-	✓
SD10B1X10FT	10B-1	0.625	✓	✓	-	✓	-	✓
SD12B1X10FT	12B-1	0.750	✓	✓	-	✓	-	✓
SD16B1X10FT	16B-1	1.000	✓	✓	-	✓	✓	✓
SD20B1X10FT	20B-1	1.250	✓	✓	-	✓	✓	✓
SD24B1X10FT	24B-1	1.500	✓	✓	✓	-	✓	✓

Duplex

Renold BS Order Code	ISO No.	Pitch inch	Connecting links					
			4	107	11	26	12	30
SD06B2X10FT	06B-2	0.375	✓	✓	-	✓	-	✓
SD08B2X10FT	08B-2	0.500	✓	✓	-	✓	-	✓
SD10B2X10FT	10B-2	0.625	✓	✓	-	✓	-	✓
SD12B2X10FT	12B-2	0.750	✓	✓	-	✓	-	✓
SD16B2X10FT	16B-2	1.000	✓	✓	-	✓	✓	✓
SD20B2X10FT	20B-2	1.250	✓	✓	-	✓	✓	✓
SD24B2X10FT	24B-2	1.500	✓	✓	✓	-	✓	✓



Nr. 4



Nr. 26



Nr. 107



Nr. 12

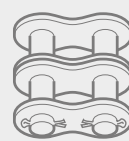

Nr. 11

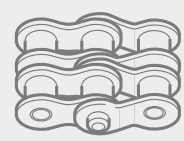

Nr. 30

Renold Stainless Steel



- All components made from austenitic rust-proof steel
- All components receive surface finishing to remove stress raisers
- Lubrication that improves wear performance
- Tensile strength is approximately 65% that of standard carbon steel chain

Renold Stainless Steel chain is made from high grades of austenitic rust-proof steel. These perform extremely well in environments that are acidic, alkaline, where direct contact with food is a consideration, where the chain will be exposed

to water, and for very high or very low temperature locations (-40° to +400°C) where resistance to corrosion is a requirement.

Renold Stainless Steel chain should be selected when resistance to

chemical action is critical.

It is manufactured using FDA approved material and is prelubricated with USDA H1 approved lubricant.

Simplex

Renold BS Order Code	ISO No.	Pitch inch	Connecting links					
			4	107	11	58	26	12
05B1SSX10FT	05B-1	0.315	✓	✓	-	-	✓	-
06B1SSX10FT	06B-1	0.375	✓	✓	-	-	✓	✓
08B1SSX10FT	08B-1	0.500	✓	✓	✓	-	✓	-
10B1SSX10FT	10B-1	0.625	✓	✓	✓	-	✓	-
12B1SSX10FT	12B-1	0.750	✓	✓	✓	-	✓	-
16B1SSX10FT	16B-1	1.000	✓	✓	✓	-	✓	-

Duplex

Renold BS Order Code	ISO No.	Pitch inch	Connecting links					
			4	107	11	58	26	12
05B2SSX10FT	05B-2	0.315	✓	✓	-	-	✓	-
06B2SSX10FT	06B-2	0.375	✓	✓	-	-	✓	✓
08B2SSX10FT	08B-2	0.500	✓	✓	✓	-	✓	-
10B2SSX10FT	10B-2	0.625	✓	✓	✓	-	✓	-
12B2SSX10FT	12B-2	0.750	✓	✓	✓	-	✓	-
16B2SSX10FT	16B-2	1.000	✓	✓	✓	-	✓	-

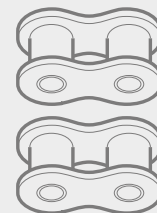

No.4

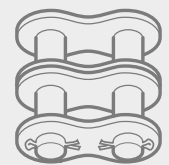

No. 11



No. 107

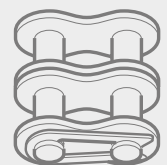

No. 26

HABIX

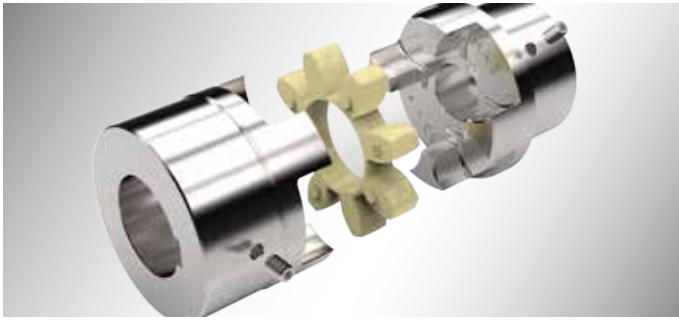

Size	Part 1		Part 2		Part 3		Part 4		All Parts	
	PB (mm)	Max. (mm)	PB (mm)	Max. (mm)	TL Bush	l_3 (mm)	TL Bush	l_4 (mm)	d_a (mm)	S (mm)
19	0	19	17	24	-	-	-	-	40	16
24	0	24	22	28	1008	22	1008	22	55	18
28	0	28	26	38	1108	22	1108	22	65	20
38	10	38	36	45	1108	22	1108	22	80	24
42	12	42	40	55	1610	25	1610	25	95	26
48	13	48	46	60	1615	38	1615	38	105	28
55	18	55	53	70	2012	32	2012	32	120	30
65	20	65	63	75	2012	32	2517	45	135	35
75	28	75	73	90	2517	45	3020	51	160	40
90	38	90	88	100	3020	51	3535	89	200	45

Size	Max. Speed RPM	Torque (Nm)				Max. Shaft Misalignment		
		White 92A Shore		Red 98A Shore		Radial (mm)	Axial (mm)	Angular (deg)
		Nominal	Changing	Nominal	Changing			
19	19000	10	2.6	17	4.4	0.2	1.2	1.2
24	14000	35	9	60	16	0.22	1.4	0.9
28	11800	95	25	160	42	0.25	1.5	0.9
38	9500	190	49	325	85	0.28	1.8	1.0
42	8000	265	69	450	117	0.32	2.0	1.0
48	7100	310	81	525	137	0.36	2.1	1.1
55	6300	410	105	685	178	0.38	2.2	1.1
65	5600	625	163	940	245	0.42	2.6	1.2
75	4750	1280	333	1920	499	0.48	3.0	1.2
90	3750	2400	624	3600	936	0.5	3.4	1.2

Habix premium quality flexible jaw couplings are machined on all surfaces for precise running characteristics and increased durability.

- Failsafe
- Wear resistant PU Inserts resistant to Oil, Ozone & ageing.
- Temperature Range : -20°C to +80°C
- Balanced to DIN ISO 1940 Q16
- Jaw material Cast Iron EN-GJL-250 (GG-25)

Type HWN

Pilot Bore

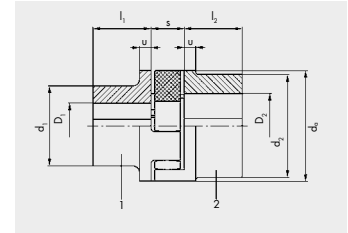

Type HWT

Taper Bore

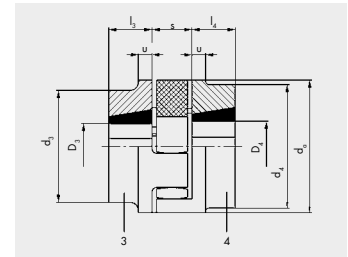

Parts 1, 2, 3 & 4 can be combined

Spider elements available in:

- 92A Shore White
- 98A Shore Red

Performance values are based on an ambient temperature of 30°C, 1500rpm and single plane misalignments. For higher speed, temperature and combined misalignments values should be reduced.

HABIX Plus – Backflash-free/Low inertia



Type HPN
Finished Bore



Type HPK
Clamping Type

- Precision press-fit of element ensures backlash-free operation.
- Aluminium construction (sizes 19-48) results in very low weight / inertia. (>48 = steel)
- Elements available in Green 65A & Orange 98A Shore
- Temperature Range -30°C to +100°C / 120°C

PEX



PEX Plug-in type jaw couplings are suitable for a wide range of applications where radial, axial and angular misalignments may be present.

- Failsafe
- Temperature Range: -20°C to +80°C
- Balanced to DIN ISO 1940 Q16

Available in two piece (B) and three piece (A) arrangements. The Type A three piece arrangement enables replacement of flexible elements without the need to move the coupled parts.

Type A

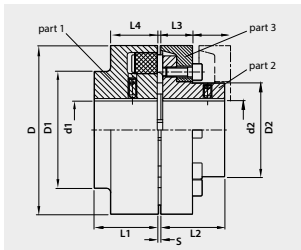

Type B

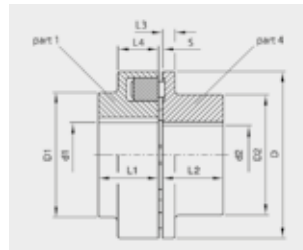

Wear indicator sticker shows when elements need to be changed. Included with all PEX couplings.



- Part 1 is common to both types and includes flexible elements
- Part 2 & 3 are supplied together

TECHNICAL DATA

Size	Nominal Torque Nm	Max. Speed RPM	Maximum Bore (mm)			D (mm)	L1 = L2 (mm)	S (mm)	Max. Misalignment		
			Part 1	Part 2+3	Part 4				Axial (mm)	Radial (mm)	Angular (deg)
58	19	7500	19	-	24	58	20	3	0.20	0.20	0.15
68	34	7000	24	-	28	68	20	3	0.20	0.20	0.15
80	60	6000	30	-	38	80	30	3	0.20	0.20	0.12
95	100	5500	42	-	42	95	35	3	0.20	0.20	0.12
110	160	5300	48	38	48	110	40	3	0.20	0.20	0.10
125	240	5100	55	45	55	125	50	3	0.25	0.25	0.10
140	360	4900	60	50	60	140	55	3	0.25	0.25	0.10
160	560	4250	65	58	65	160	60	4	0.30	0.30	0.10
180	880	3800	75	65	75	180	70	4	0.30	0.30	0.10
200	1340	3400	85	75	85	200	80	4	0.30	0.30	0.09
225	2000	3000	90	85	90	225	90	4	0.35	0.35	0.09
250	2800	2750	100	95	100	250	100	6	0.35	0.35	0.08

ORPEX

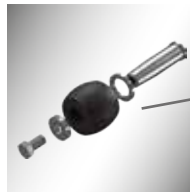

Orpex Pin & Buffer type couplings are ideal for heavy duty flexible coupling applications.

- High reliability / failsafe operation
- Temperature Range : -30°C to +80°C
- Balanced to minimum DIN ISO 1940 Q16. Finer balancing is possible and recommended for circumferential speeds >30m/s
- Available in Type WN cast iron as standard or Type WS steel optional for very high speed applications.
- Larger sizes up to size 2000 with bore up to 640mm and torque transmission capability up to 1,300,000 Nm are available on request.
- Replacement bolts & buffers available

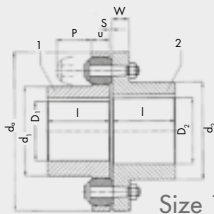

Size 105-360

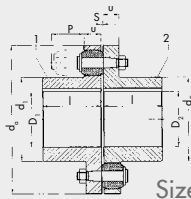

Size 400

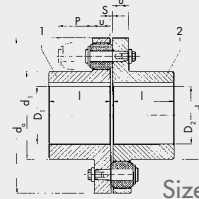

Size 450-500

TECHNICAL DATA

Size	D ₁ Max. (mm)	D ₂ Max. (mm)	d ₀ (mm)	l (mm)	S (mm)	No. Bolts & Buffers	∅ Bolt & Buffer	Nominal Torque Nm	Speed RPM
105	32	38	105	5	2...4	8	M6	200	5000
125	40	48	125	50	2...4	8	M8	350	5000
144	45	55	144	55	2...4	10	M8	500	4900
162	50	60	162	60	2...5	9	M10	750	4300
178	60	70	178	70	2...5	10	M10	950	3800
198	70	80	198	80	2...5	12	M110	1300	3400
228	80	90	228	90	2...5	11	M12	2200	3000
252	90	100	252	100	2...5	12	M12	2750	2700
285	100	110	285	110	3...6	11	M16	4300	2400
320	110	120	320	125	3...6	12	M16	5500	2100
360	120	130	360	140	3...6	10	M18	7800	1900
400	140	140	400	160	3...6	14	M18	12500	1700
450	160	160	450	180	4...7	12	M16	18500	1500
500	180	180	500	200	4...7	14	M16	25000	1350

OPTIBELT COUPLING RANGE

In addition to the couplings detailed on the preceding pages, Optibelt offer a wide range of flexible and rigid couplings for all applications.



FLEX

- Two Tyre options: Standard & FRAS
 - Taper or Pilot bore options
 - To suit shaft sizes 10mm-190mm
- Common Tyre type flexible coupling for reliable transmission of high levels of misalignment.



HRC

- Taper or Pilot bore options
 - To suit shaft sizes 10mm-115mm
- Popular, general-purpose flexible jaw coupling.



MINI

- One piece or two piece clamping hubs
 - To suit shaft sizes 3mm-40mm
 - Aluminium or steel / stainless options
- Beam type torsioally rigid / backlash-free flexible coupling. Ideal for servo and positioning drives.



GEAR

- Shaft \varnothing up to 1000mm
 - Torque up to 8,000,000Nm
 - Premium or Eco options available
- Torsioally rigid, with greased, crowned gearing to reliably accommodate misalignments on extremely heavy drives.



FERROFLEX-N

- Torque up to 10,000Nm
 - Temperature up to 280°C
 - Maintenance-free
- Torsioally rigid, backlash-free with spring steel discs allowing flexible compensation of misalignments.



FLANGE

- Shaft \varnothing up to 500mm
 - Torque up to 1,425,000Nm
 - Cast iron or steel options
- Robust and reliable rigid shaft connection, able to transmit radial and axial loads.

Fluid Circulation Specialists

Industry Leading Sales, Manufacturing & Service for the UK Pump Industry

MOTOR
PUMP &
GEARBOX

Trusted by the Best



Pump Sourcing & Distribution

With access to in excess of £3m stock holding within the UK – we are perfectly placed to cater for all your pumping needs.

With the teams expansive product knowledge, we know which products to advise on to suit various applications enabling quick delivery timeframes.

From circulators to submersibles and everything in-between – We can get it all.





System Commissions

Increasingly complex pump systems require precise set up to ensure maximum efficiency and optimum performance.

We don't just deliver product to site and leave it there – We also offer the service of either working alongside your engineers to install or fully offer the commissioning of products to your requirements.

From single pump, to bespoke booster and complete packaged plantroom commissioning; We can offer it all.

Product Servicing

Some products make commercial sense to maintain for longer periods of time through planned/preventative maintenance.

We can offer routine maintenance contracts on an annual or bi-annual basis to suit customer requirements.

Where others may struggle with less widely used pumps – particularly industrial pumps; this is where our knowledge base really makes our engineers stand out over and above the competition.



MOTOR
PUMP &
GEARBOX



Booster Sets

Covering premium booster sets, combined booster and tank sets – Along with the Trebles Eco-Boost and Eco-Boost+ ranges.

These units are available in single, twin and multiple pump arrangements.

We can offer custom made or bespoke booster sets to suit our customer's specific needs. These can include external applications where equipment is enclosed within a weatherproof kiosk.

Centrifugal Pumps

Manufactured as standard with cast iron or stainless steel pump body. Suitable for pumping hot and cold, moderately aggressive liquids.



Single Stage Pumps

Manufactured as standard with cast iron or stainless steel pump body. Suitable for pumping hot and cold, moderately aggressive liquids.

Available: Close-coupled with special motor shaft extension, stub shaft and standard motor or with flexible coupling, adapter, base and standard motor in compliance with EN 733 – DIN 24255.



Multistage Pumps

Using multiple impellers on a common shaft to delivery high pressure, their corrosion resistant liquid-ends and heavy-duty drive-ends are essential features in continuous duty applications.

Available: In vertical and horizontal for boiler feed, carwash, washdown, pressure cleaning, reverse osmosis, chemical and oil processing.



Circulator Pumps

The most common heating pumps are these small (generally under 2kw), single phase, high efficiency circulators.

Available: In single or twin head versions.



Inline Pumps

For larger heating and cooling application as well as process pumps, these inline designs can be single or three phase powered, fixed speed or inverter driven.

Available: In single or twin pump versions.



Self-Priming Pumps

Ideal for transporting liquids containing solids in suspension. Suited for applications where the main feature is the difficulty in priming and are used across industry, construction and emergency.

Available: In cast iron, marine bronze or stainless steel.



Submersible Pumps

For use in markets ranging from water and wastewater treatment, raw water supply, abrasive or contaminated industrial processes, mining and irrigation.

Available: As a stand-alone pump, with or without integral level control, or as an easy install packaged pumping station ensuring minimal on-site work.

MOTOR
PUMP &
GEARBOX

Positive Displacement Pumps

Self-priming by design. Suitable for handling viscous products which may also contain solids.



Air Operated Pumps

Air Operated Diaphragm Pumps are easy to use and maintain, have infinitely variable flow control, can suction lift up to 8m, run dry and operate against closed valve without damage.

Available: In a variety of both metal and plastic constructions.



Progressive Cavity

Ideal for handling slurries, viscous and shear sensitive products. Multi-stage pumps are available for high pressure applications or where accurate dosing is required.

Available: In a variety of metals with a huge array of stator materials to suit any application.



Gear Pumps

Used in industrial plants for pumping liquids of any viscosity without solids in suspension: Chemicals and petroleum products, soaps and detergents, adhesives, paint and ink, high temperature liquids and chocolate.

Available: In external and internal gear options.



Screw Pumps

They can handle virtually any non-homogenous fluid, regardless of viscosity, lubricity or abrasiveness e.g. seawater, bitumen, molasses, lime, acid, caustic solution or hydrocarbon.

Available: In high pressure, high capacity, compact and hygienic versions.



Flexible Impeller Pumps

Reversible pump offers smooth, low pulsating, low shear flow. Stainless steel and bronze casings are available for hygienic and marine applications.

Available: Impellers are produced in a variety of materials, (e.g. Natural Rubber, Neoprene, Nitrile and EPDM) making them compatible with a range of fluids.



Peristaltic Pumps

Hose pumps are seal-less, can dry run without damage and self-prime up to 9.8m. Used widely for pumping minerals, ceramics, chemicals and inks/dyes at pressures up to 15 bar.

Available: As a close-coupled unit, constructed in Aluminium or Cast Iron and with a wide variety of hose materials suitable for any application.

MOTOR
PUMP &
GEARBOX

Specialist Pumps

Available in a variety of configurations, materials and finishes appropriate for a huge range of specialist applications.



Dosing Pumps

These are used for precise dosing of fluids with highly varied viscosities, most of which are chemically aggressive and toxic, and some of which are actually abrasive or emit gasses.

Available: In solenoid, motor and stepper motor driven, diaphragm and piston construction.



Drum Pumps

Drum and container pumps are constructed to assure safety and economy when transferring neutral, aggressive and flammable liquids from different-sized containers. Used for pumping aqueous and light viscous liquids.

Available: In a variety of standard materials and stem lengths.



Hygienic Pumps

Designed to reduce the build-up of bacteria by minimising crevices and dead areas. Consideration is paid to the ease with which the pump can be disassembled for manual cleaning.

- Centrifugal,
- Self-priming
- Cleaning-in-place



Rotary Lobe Pumps

Hygienic – approved to relevant standards, offering gentle pumping action to suit viscous, delicate and particle-laden liquids. Easy to clean, easy to maintain.

Available: In AISI316 stainless steel construction.



ATEX Pumps

For hazardous areas, we can provide ATEX pumps and safety devices.

If you have specific flammable gasses or dust present in the atmosphere and temperature limit requirements within the pump installation envelope, we can provide you with a solution.



Packages

Off the shelf or bespoke, automatic packaged sets, designed and built to the highest standards.

Available: In fixed or trolley mounted configuration, fixed or variable speed, complete with pipework, valves, control panel and flow / pressure / temperature sensors.

MOTOR
PUMP &
GEARBOX

Our pump brands we supply:



MOTOR
PUMP &
GEARBOX



VF W series worm gearmotors

Torque range 13 ... 7,100 Nm
Mechanical rating 0.04 ... 75kW
Gear ratios 7 ... 10000



C series in-line helical gearmotors

Torque range 45 ... 12,000 Nm
Mechanical rating 0.08 ... 213kW
Gear ratios 2,6 ... 1481



A series helical bevel gearmotors

Torque range 100 ... 14,000 Nm
Mechanical rating 0.22 ... 150kW
Gear ratios 5,4 ... 1715



300 series planetary gearmotors

Torque range 1,000 ... 1,100,000 Nm
Mechanical rating up to 450 kW
Gear ratios 3,4 ... 5000



S series single reduction helical gearmotors

Torque range 21 ... 200 Nm
Mechanical rating 0.12 ... 11,6 kW
Gear ratios 1,4 ... 13,1



TA series shaft mounted speed reducers

Torque range 150 ... 16,000 Nm
Mechanical rating 1,1 ... 156 kW
Gear ratios 5 ... 31,5



 **Bonfiglioli**
We engineer dreams

Our philosophy has always been to keep things simple. Why overcomplicate things looking for a magic formula. In today's market stocking complete geared motors is no longer the solution. To ensure a fast reliable service and short lead times local assembly is the way forward, achieved by investing in build centres across the world.

Our formula for success is simple...

Local assembly = fast reliable delivery = less downtime

MOTOR
PUMP &
GEARBOX



RAN series bevel gearboxes

Torque range 3 ... 3,000 Nm
Mechanical rating 0.15 ... 91 kW
Gear ratios 1 ... 7,4



F series shaft mounted gearmotors

Torque range 140 ... 14,000 Nm
Mechanical rating 0.17 ... 125 kW
Gear ratios 6,4 ... 2099



HDO series bevel helical gear units (Heavy Duty)

Torque range 25,650 ... 194,050 Nm
Gear ratios 5,6 ... 400



HDP series parallel shaft gear units (Heavy Duty)

Torque range 5,000 ... 194,050 Nm
Gear ratios 7,1 ... 500



BN series AC motors & brake motors

kW rating 0.06 ... 30 kW
Frame sizes 56A ... 200L
Compliance 2006/95/EC (LVD) & 2004/108/EC (EMC)



BX series IE3 premium efficiency AC motors

kW rating 0.75 ... 22 kW
Frame sizes 80B ... 180L
Compliance IEC 60034-30:2008(IE), 640/2009/EC 2006/95/EC (LVD) & 2004/108/EC (EMC)

MOTOR
PUMP &
GEARBOX



HDO Series
The new generation



Historically Bonfiglioli has always been well known in the market for high quality worm gearboxes and small to medium power geared motors. Much has changed since 1956 with significant investment in the heavy duty gearbox range putting us firmly on the map for this sector.

The range now offers output torque ratings up to 1.25 million Nm with higher ratings being developed.

Demanding applications? Don't compromise on quality.

THE SOURCE FOR INDUSTRY

PEMBROKE
West Wales Office

MERTHYR TYDFIL
South Wales Office

NEWBURY
Head Office

HEAD OFFICE

Advantiv Limited
Unit 9 Kingfisher Court
Newbury
Berkshire RG14 5SJ
Tel: 01635 246188
Email: sales@advantiv.co.uk
www.advantiv.co.uk

SOUTH WALES OFFICE

Unit 9 Pant Industrial Estate,
Merthyr Tydfil
Mid Glamorgan
CF48 2SR
Tel: 01685 708708
Email: merthyr@advantiv.co.uk
www.advantiv.co.uk

WEST WALES OFFICE

8 Bridge Innovation Centre
Pembroke Science & Technology Park
Pembroke Dock
Pembrokeshire SA72 6UN
Tel: 01646 689211
Email: wales@advantiv.co.uk
www.advantiv.co.uk

Advantiv supply a wide range of tools, MRO products, consumables and engineering services to customers nationwide. Quality brands at competitive prices.



www.advantiv.co.uk

Contact your local branch for full details on our range of products including those not listed in our catalogue.