



FOOD AND BEVERAGE

EFFICIENT APPLICATION SOLUTIONS

SICK
Sensor Intelligence.



TABLE OF CONTENTS

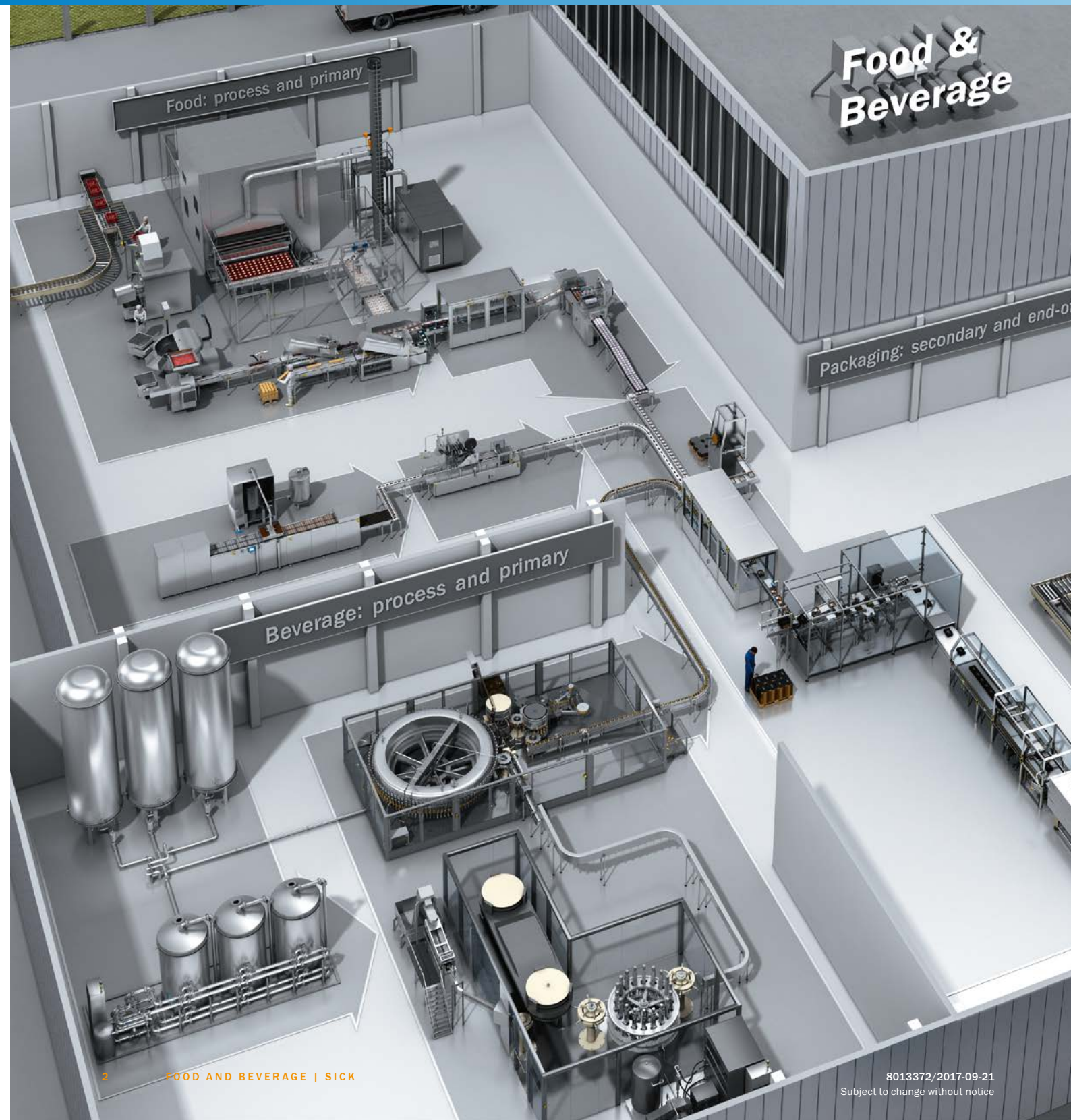



More information on the
food and beverage industry
→ www.sick.com/food_and_beverage



Challenges

Challenges in the food and beverage industry 4

Applications in focus

The application graphics shown are not binding, they are no substitute for the need to seek expert technical advice.

Food processing 6

Beverage production 16

Primary food packaging 22

Primary beverage packaging 32

Secondary packaging 42

End of line packaging 52

Special pages

Flexible automation 60

Safety 62

Quality control 64

Track and trace 66

Hygienic solutions 68

Products

Product overview 70

General information

Additional expert knowledge 130

Company 132

Industries 134

SICK LifeTime Services 136

Versatile product range for industrial automation 138

Industrial communication and device integration 142

Notes 143

Service 147

CHALLENGES IN THE FOOD AND BEVERAGE INDUSTRY

The industrial future will be shaped by much more interconnected production and control processes. Maximum productivity with product variants down to “batch size 1” is a central target of the Industry 4.0 concept. It must be possible to adjust manufacturing systems to the individual customer requirements, whereby intelligent sensors control themselves. With complete integration into the control level, particular attention is placed on the decentralization of certain automation functions into the sensors, both to ease the burden on the control and increase machine productivity. SICK offers sensors, sensor systems and solutions for the packaging industry that are tailored to complex, frequently changing tasks, while meeting the increasingly challenging standards for trademark protection, safety, and documentability.



Flexible automation – Detecting and Measuring

Differently sized products and individual customer requirements require flexible machines and a broad spectrum of intelligent sensors to detect objects and measure physical sizes. SICK’s smart sensors feature automated teach-in and diagnostic capabilities, and make a significant contribution towards meeting these challenges. Predictive maintenance reduces downtimes. Smart tasks provide process efficiency with the right information at the right time, directly from the sensor. This makes Industry 4.0 a reality.

Safety – Protection

The modular construction of modern packaging machines and plants requires an intelligent and flexible safety concept. SICK safety solutions ensure the protection of personnel and machines, optimize production and reduce machine footprint requirements. Our central task is to develop and offer safety technology services which are standardized all over the world. These include commissioning, repair and modernization. As an accredited inspection center, SICK offers the inspection of protective measures worldwide in accordance with valid standards and regulations.

Quality control – Monitoring and Controlling

In all areas of the packaging industry – whether it is pharmaceuticals, cosmetics, food and beverages, household goods, or hygiene – reliable quality is one of the key corporate targets. In order to ensure constant high quality with high throughput speeds on packaging machines, a quality control system is needed that meets the highest requirements. Whether it is standard sensor technology, complete systems or services, SICK offers state-of-the-art intelligent sensor solutions for all areas of the packaging industry. After all, quality is never an accident.



Track and trace – Identification and Tracking

Reliable identification of objects is the foundation for traceability with serialization and aggregation and for continual quality improvement. In addition, complete system solutions are required for inventory management and reusability of returnable containers and packaging. To do so, SICK offers intelligent sensor solutions, ranging from compact devices that are easy to integrate, through configurable standalone solutions, and right the way up to programmable high-speed cameras. In its permanently installed and mobile readers, SICK uses different technologies to detect bar codes, 2D codes and RFID.

Hygienic solutions

No build-up of germs means no product risk: That really is how simple the equation is when it comes to systems which process food, bottled drinks, or produce pharmaceuticals. With the sensor solutions in Hygienic Design and meeting the recommendations of the EHEDG (European Hygienic Engineering & Design Group), SICK offers systematic sterility combined with well-conceived functionality in applications for track and trace, safety, quality control and flexible automation.

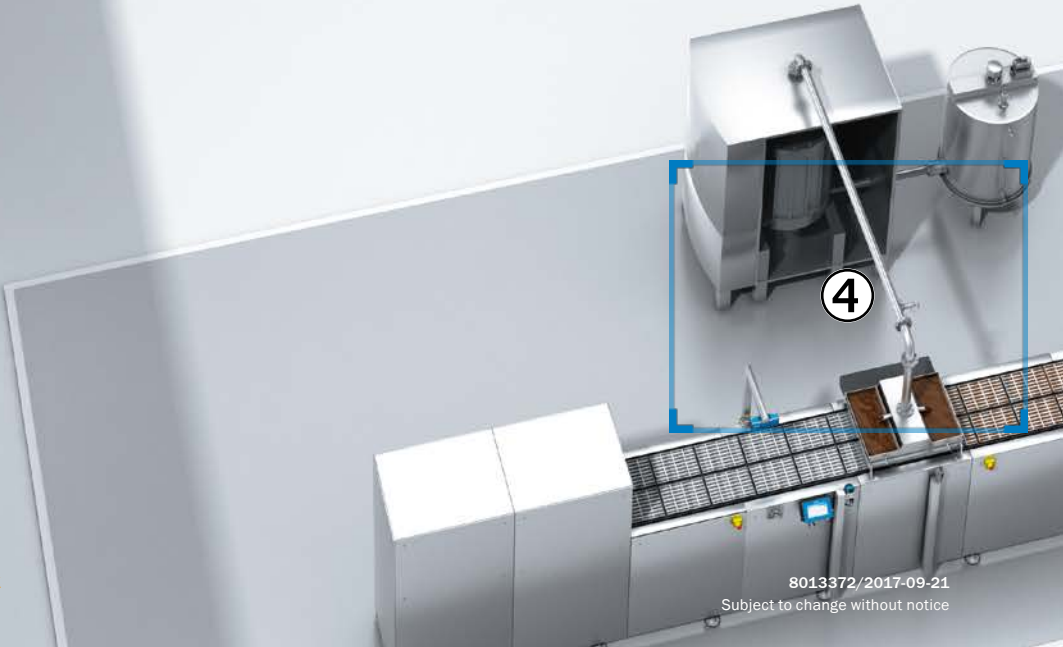
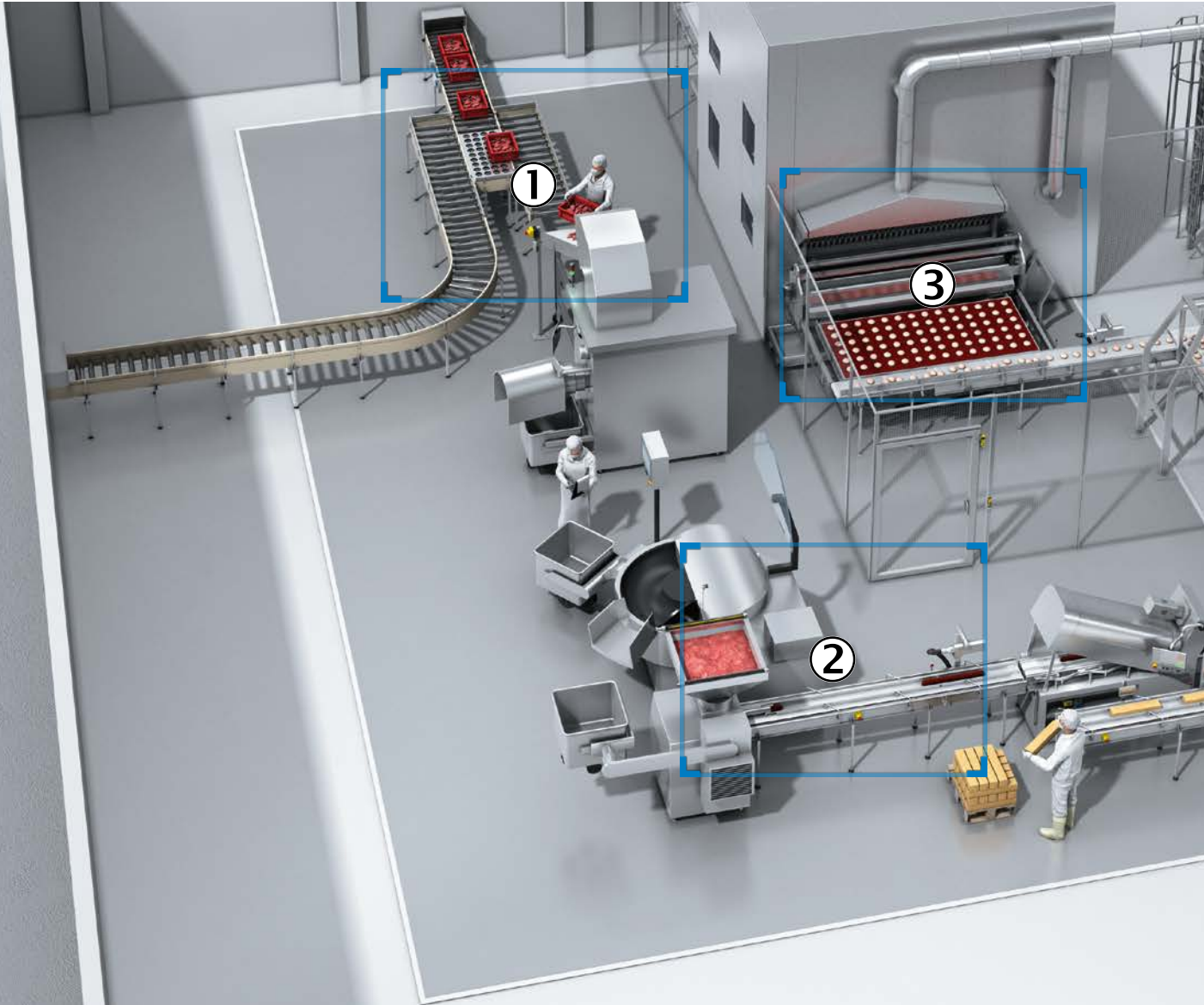



Food processing

Focus 1	8
① Transportation, mixer, and filler	
Focus 2	10
② Meat and cheese slicer	
Focus 3	12
③ Oven (rolls)	
Focus 4	14
④ Tank, pouring machine (candy)	

① Detection of transport crates on conveyor belt

Photoelectric sensors in an Inox housing are used in the meat industry to reliably detect transport crates on the conveyor belt. The rugged G6 Inox miniature photoelectric sensor has been designed for harsh ambient conditions and is able to withstand washdown cleaning cycles in the food sector.



G6 Inox → p. 73

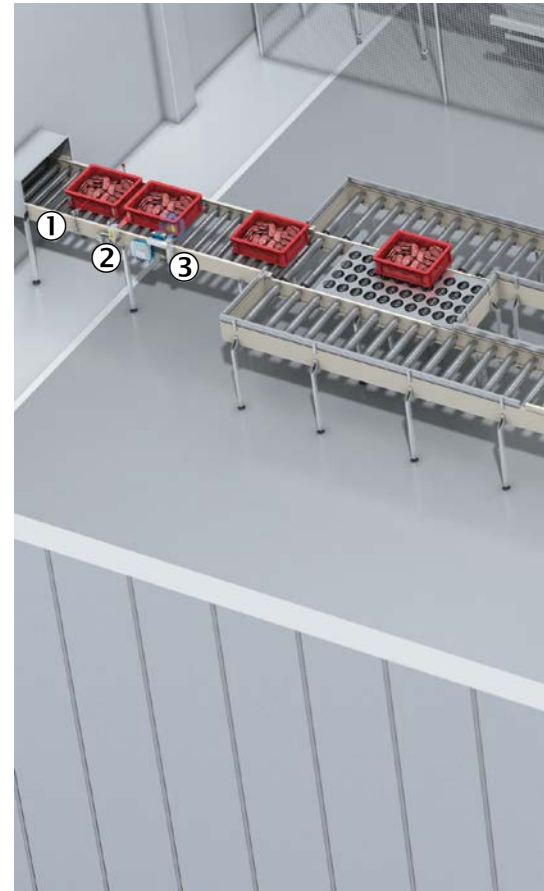

② Reading of bar codes on transport crates

In the meat-processing industry, 1D bar codes have to be read in difficult and harsh conditions. The CLV64x bar code scanner with rugged stainless-steel housing masters this demanding task and is suitable for continuous use. The stainless-steel housing is also able to withstand temperature fluctuations and intensive cleaning cycles.

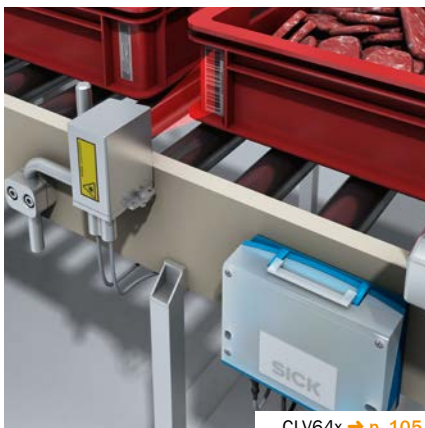

CLV64x → p. 105

③ Intelligent process control based on specific tag data

In the meat industry, RFID tags on the transport crates help to achieve intelligent process control. The tags contain all the necessary data. An RFU62x RFID writes the tags and reads out the data. Thanks to the fact that all established data interfaces and fieldbuses are supported, exchanging data with the control center is easy. In addition, the RFID offers a range of diagnostic functions.

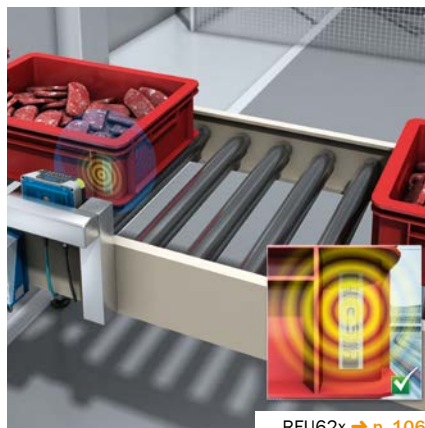

RFU62x → p. 106

④ Sensing of loading cart position

Accurate positioning of the loading cart is important for transporting the product in exactly the right position in the loading cart and so ensuring safe, hygienic further processing of the product. Cylindrical photoelectric sensors like the GR18 Inox cylindrical photoelectric sensor are ideal for this task. Thanks to their compact design, such sensors can be incorporated into the machine design even in applications where there is not much installation space.



GR18 Inox → p. 77



⑤ Changeover of machinery to a new product

When setting up the cutter for a new product to be processed, a very wide range of parameters needs to be set via a control panel. The IDM14x hand-held scanner reads in the bar code of the new product and the machine is then set to the corresponding parameters automatically.

⑥ Level monitoring in the storage container

Level monitoring of the storage container is very important for ensuring the process flow of a filler when processing the product. The Dx35 mid range distance sensor or the UM30 ultrasonic sensor can be installed at a safe distance from the filling product in order to continually measure the level and relieve some of the burden on the operating personnel.

⑦ Hazardous point protection on the storage container

To ensure a safe process flow, it is very important to protect the hazardous point on the storage container used to feed in the meat. This is where the deTec4 Core IP69K safety light curtain protective housing comes in. It provides reliable hazardous point protection and, due to its rugged material, is resistant to high-pressure cleaning. It is also particularly suitable for use in hygienic environments thanks to its smooth surface.



IDM14x → p. 107

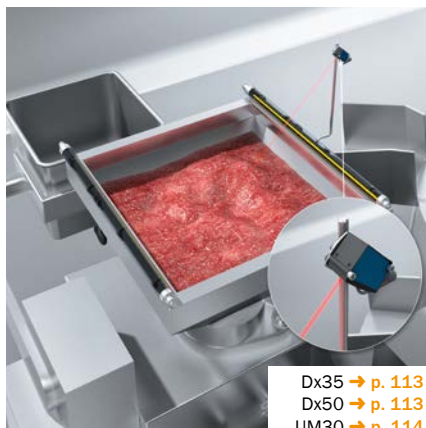

Dx35 → p. 113
Dx50 → p. 113
UM30 → p. 114

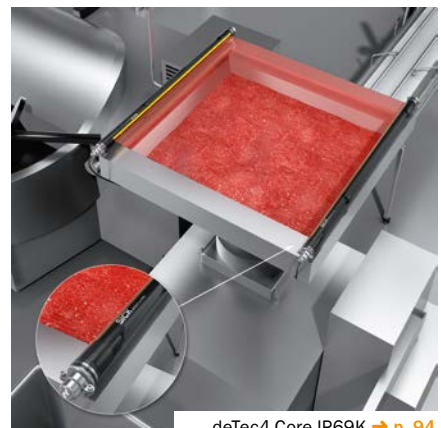

deTec4 Core IP69K → p. 94

① Mounting system for use in a hygienic environment

Hygienic environments such as those found in the meat-processing industry require suitable sensors and mounting systems. The Hygienic Design mounting system really minimizes the risk of the manufactured product being affected by microbacterial contamination. The mounting system is flexible in application thanks to its rotating and height-adjustable telescope arm. It delivers an efficient and hygienic complete solution when combined with the W4S-3 Inox Hygiene reflector and miniature photoelectric sensor.



W4S-3 Inox Hygiene → p. 75



② Optimization of the cutting process using 3D vision

Form and volume measurements optimize cutting processes in foods such as meat and, as such, save on costs. An exact, three-dimensional measurement of any product shape reduces waste. The IVC-3D 3D vision sensor with its stainless-steel housing is ideal for the high hygiene requirements of the food industry and can withstand aggressive cleaning. The compact housing of the 3D vision combines the functions of image processing, lighting, and evaluation.



IVC-3D → p. 109

③ Detection of the product being fed into the meat slicer

An essential part of process control at the meat slicer infeed is for the piece of meat to be reliably detected. The GR18 Inox cylindrical photoelectric sensor in a stainless-steel housing, used in combination with stainless-steel reflectors, is ideal for this task. Thanks to the short M18 housing, the sensor can be integrated into the machine design perfectly.



GR18 Inox → p. 77

④ Reliable detection in harsh and hygienic environments

Foods such as slices of salami should follow each other on the conveyor belt arranged correctly. Reliable detection of gaps prevents problems in the production process. The WTB4S-3H photoelectric proximity sensor with precise PinPoint technology is the right choice here. With its teach-in button that can be sterilized, the rugged stainless-steel housing meets the requirements for cleaning processes in the food industry.



W4S-3 Inox Hygiene → p. 75

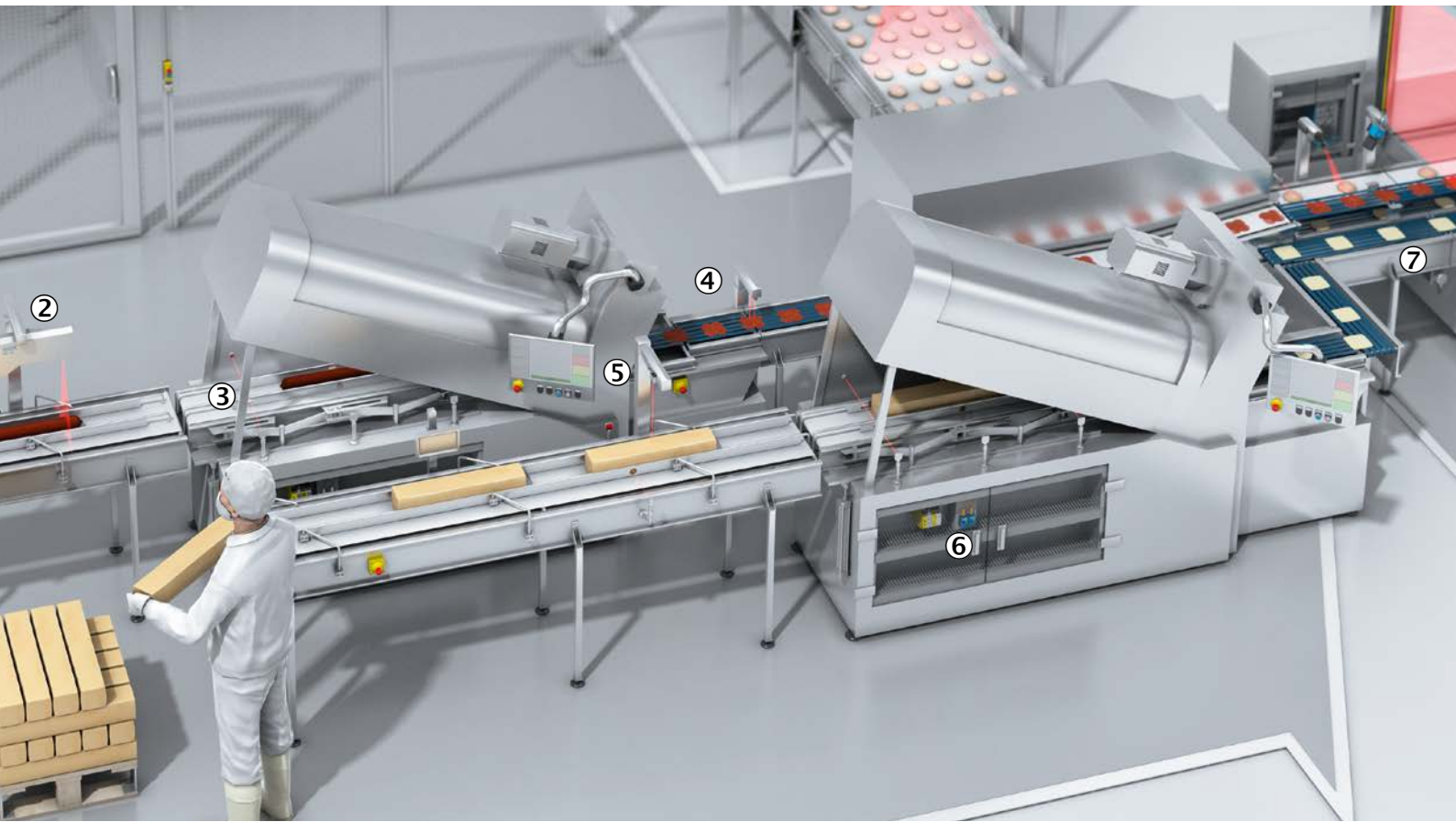

⑤ Profile measurement of the sliced block of cheese

An essential part of accurately and easily measuring the height profile of the block of cheese at the cheese slicer infeed is for the product to be reliably detected. When taking measurements, the OD Mini displacement measurement sensor determines distances of up to 250 mm with a resolution down to the μ range in order to reduce waste, for example. The sensor can be commissioned quickly and easily via a display.



OD Mini → p. 111

⑥ Measurement of pneumatic pressure on a meat slicer

The system pressure must be monitored in order to improve the efficiency of a meat slicer and preserve resources. The PAC50 electronic pressure switch is particularly well suited to this application. Thanks to its three large function buttons and large display, it is easy to use. The color of the digits on the pressure switch display indicates whether the system pressure is within the target range. The optional IO-Link interface of the PAC50 reduces downtimes when changing formats and the sensor.



PAC50 → p. 120

⑦ Precise speed measurement on conveyor belts

An essential part of process control involves synchronizing the conveyor belt speed at the cheese slicer outlet with downstream machines. The DFS60 Inox incremental encoder continuously measures the actual value signal for the speed in order to reliably control the downstream process. Thanks to its IP67 enclosure rating, it is particularly suitable for use on machines in hygienic areas and wet zones.

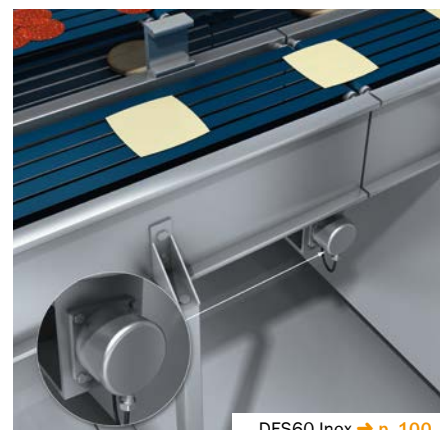

DFS60 Inox → p. 100

① Protection of the door at the oven outfeed

Oven systems are divided into various sections. Oven infeeds and outfeeds are used to feed products into the system and finish manufacturing them. Unauthorized access to the oven outfeed must be prevented. A TR10 Lock safety locking device must be installed on the oven outfeed door to protect it. The rugged housing with IP69K enclosure rating makes the TR10 Lock particularly suitable for use in areas with intensive cleaning requirements.



TR10 Lock → p. 96



② Detection of the product at the oven outfeed

In industrial baked goods production, an efficient and productive manufacturing process is ensured by reliable and precise detection. A WTB4S-3V photoelectric proximity sensor at the oven outfeed performs this task. The smooth stainless-steel housing is fitted with a teach-in button that can be sterilized and, like all photoelectric proximity sensors of the W4S-3 Inox product family, meets stringent hygiene requirements.

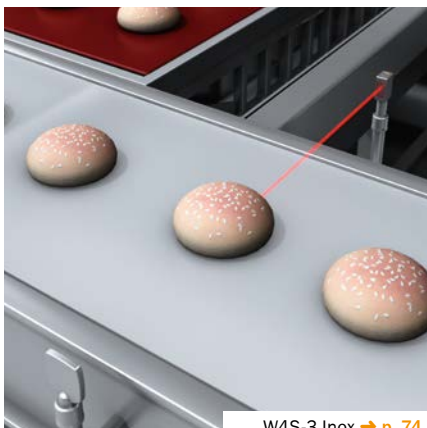

W4S-3 Inox → p. 74

③ Check of shape and dimension

Shape and dimension measurements are an important part of the production process for foods. This enables defective products to be detected and removed. An exact, three-dimensional measurement of any definable product shape ensures an optimal result. The IVC-3D 3D vision sensor in a stainless-steel housing is ideal for high hygiene requirements and combines the functions of image processing, lighting, and evaluation.

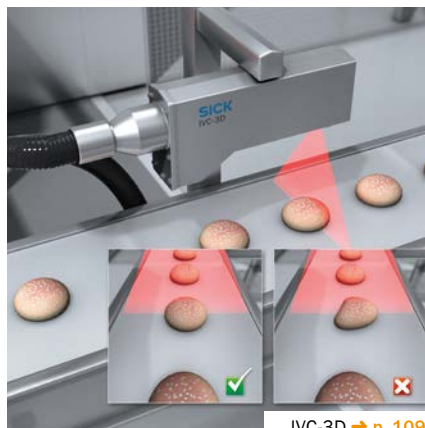

IVC-3D → p. 109

④ Determination of where the product is positioned on the conveyor belt

Precise position detection is required for monitoring a baking line and, if necessary, for rejecting incorrectly placed rolls with the aid of a robot. By synchronizing several 2D LiDAR sensors (2D laser scanners) of the LMS4xx product family, it is even possible to perform full detection of particularly wide conveyor belts if required. The calculated position data is transmitted to the Delta robot in real time for evaluation. This does away with loss of quality and machine downtimes.



LMS4xx → p. 116

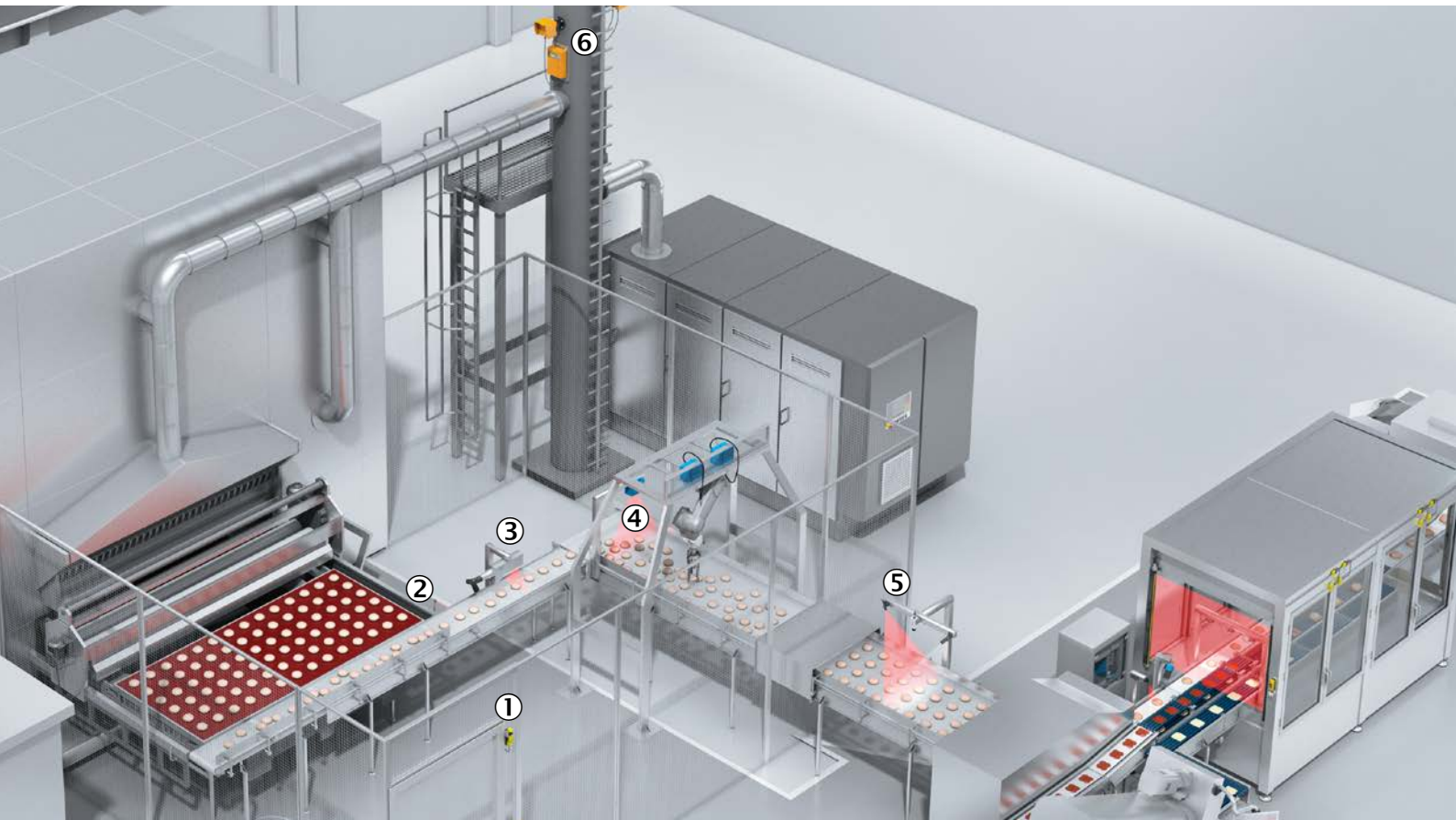

⑤ Quality control – Browning of baked goods

A number of properties must be checked in order to safeguard the quality of baked goods and to ensure that sorting is performed correctly. This includes the browning specification, amongst other things. To achieve this, the inspection system used must be capable of measuring both volume

and color features at high speed, but with a good resolution at the same time. The ColorRanger E 3D streaming camera meets these requirements. This extremely flexible camera's speed, resolution, and field of view can be adapted to the production line in question.

⑥ Electricity generation – Monitoring of recirculation air

Having an efficient power plant generating electricity and heat requires continuous monitoring and optimization of the combustion process, e.g., regarding the CO concentration. In-situ analysis provides the fast response necessary for control. The GM901 in-situ gas analyzer, "cross-duct" design, is suitable for this task. It is also used to monitor CO point levels in drying and roasting plants (e.g., for coffee, peanuts, malt) and for general process monitoring purposes in the food industry.

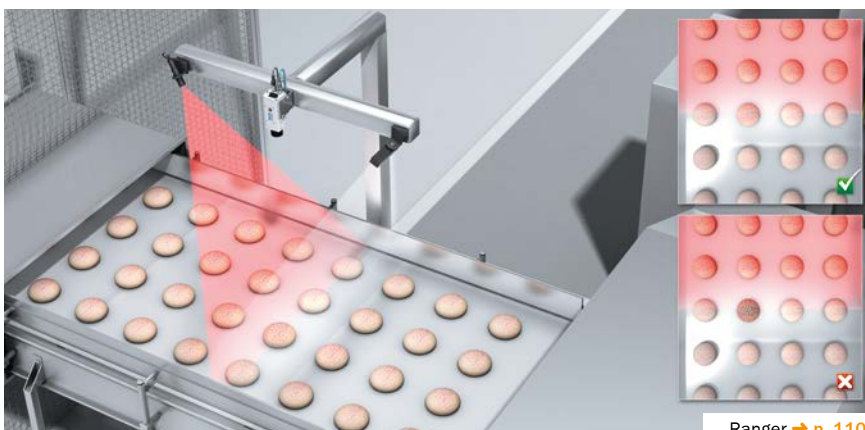

Ranger → p. 110



GM35 → p. 99
GM901 → p. 100

① Empty mold detection at pouring machine infeed

Before they are filled with chocolate, the molds must be empty and clean. Incorrect filling may result in dissatisfied customers and recalls. Entire pallets are often sent back to the manufacturer in this case, resulting in costs which could be avoided. The TriSpector1030 3D vision sensor scans moving or stationary molds and reliably detects whether or not they contain residue. Once the chocolate has been removed from the molds, an additional check must be performed to ensure that no parts of the mold have got into the chocolate.



② Identification of molds using the Asset Monitoring System

Identification and traceability play an important role in the food industry. Chocolate molds must be checked and, if necessary, replaced after a certain number of usage cycles. The Asset Monitoring System compares the 1D or 2D codes of the molds with the saved data and shows them on the HMI. The Asset Monitoring System offers intuitive operation via an HMI with touch display and can be easily retrofitted to existing machines.



③ Positioning of molds during filling

An important process step is the positioning of the molds below the pouring machine prior to filling. The Ax20E array sensor enables a mold to be accurately positioned. The Ax20E is immune to ambient light and does not require an additional reflector.



④ Point level measurement on chocolate filling hoppers

Level monitoring in the storage containers is an important way of ensuring a smooth process flow at a pouring machine. The MHF15 level sensor is suitable for this purpose. The sensor is wear-free, maintenance-free, and works in liquid media. The small and compact sensor is ideal for difficult installation conditions. The stainless-steel housing means it is highly resistant to cleaning and FDA-compliant.





⑤ Monitoring of the pouring machine supply cable

Monitoring of the pouring machine supply cable ensures that the dry-run protection of the supply cable is safeguarded, for example. The LFPV200 vibrating level switch is the right choice here. It is wear-free, maintenance-free, and can be used in all types of liquid. In the hygienic design, the housing has a particularly high surface quality and aseptic process connections.

⑥ Level measurement at storage tanks

Storage tanks must be full to a certain level to safeguard the supply of liquid to the pouring machines. The LFP Inox level sensor reliably measures hot and sticky media. Using FDA-compliant materials, EHEDG-certified design, and CIP and SIP resistance, the LFP Inox is suitable for applications with stringent hygiene requirements.

⑦ Measurement of the temperature profile in the storage tank

When producing candy, continuous monitoring of temperature profiles and the corresponding adaptation of the temperature in the tanks are very important in ensuring a constant, stable process. The TCT temperature sensor is a Pt100 resistance thermometer that complies with hygiene requirements. The product has been designed with no gaps and is made of corrosion-resistant stainless steel, this sensor meets stringent hygiene requirements.



LFPV200 → p. 118



LFP Inox → p. 118



TCT → p. 122

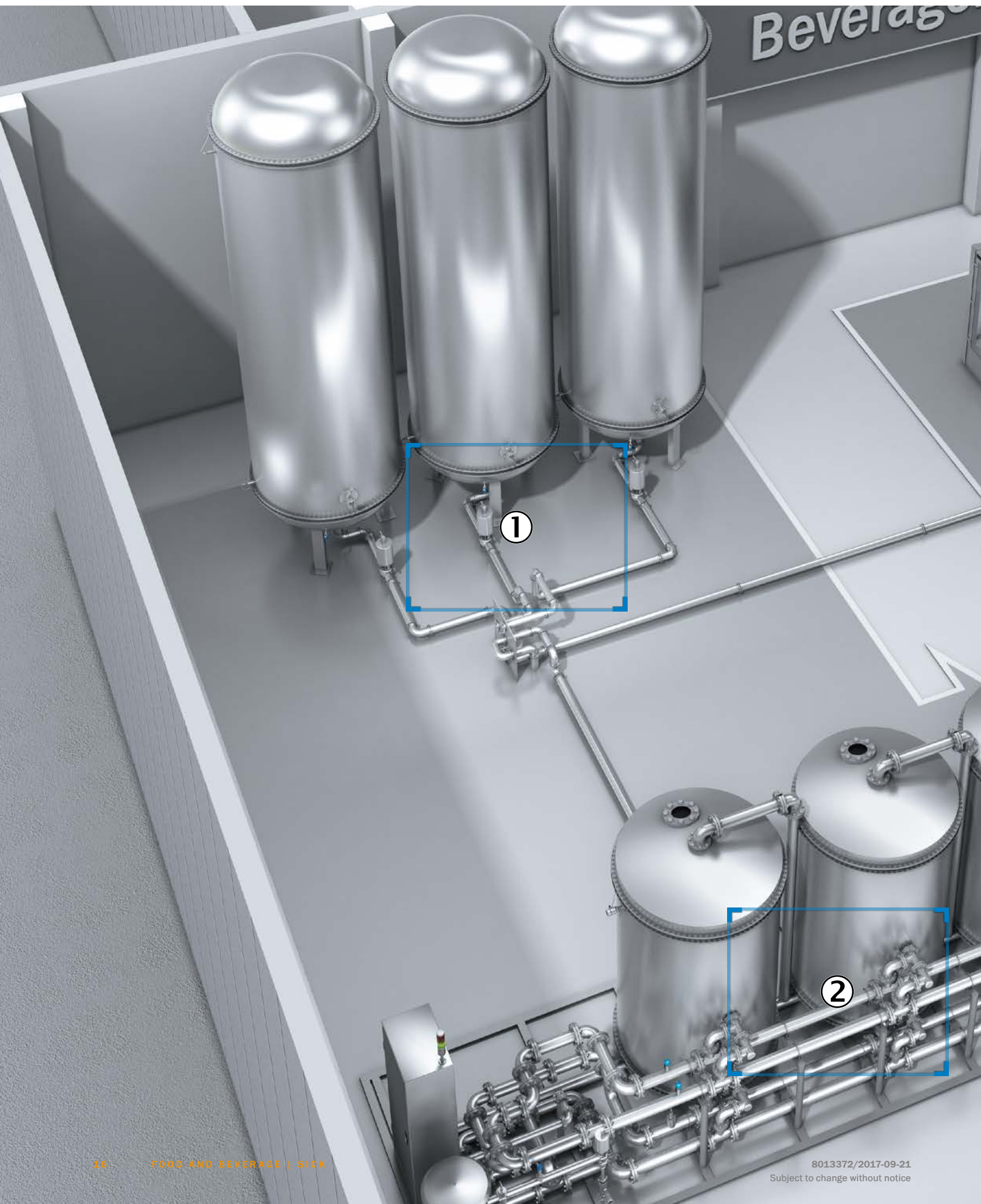



Beverage production

Focus 1

18

- ① Storage tank and conveying line

Focus 2

20

- ② CIP system

① Point level measurement in storage tanks

Point level measurement in storage tanks ensures that the overfill protection, empty signal, and dry-run protection for pumps are safeguarded, for example. The LFBV200 vibrating level switch is the right choice here. It is wear-free, maintenance-free, and can be used in all types of liquid. In the hygienic design, the housing has a particularly high surface quality and aseptic process connections.

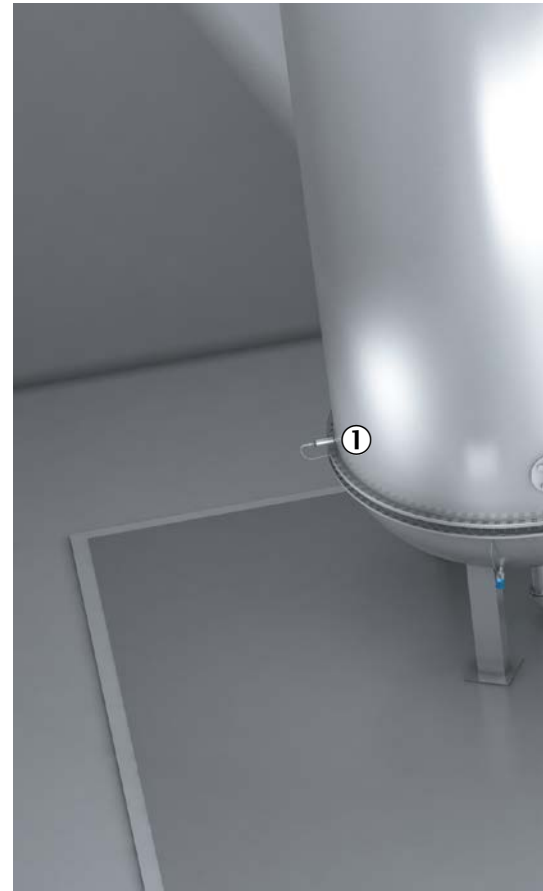

② Measurement of temperature in supply tanks for bottling systems

In beverage production, the temperature in the supply tanks for bottling systems is to be monitored constantly. As the temperature sensor comes into contact with the product, it must meet stringent hygiene requirements. The THT temperature sensor used for this is a Pt100 resistance thermometer that complies with hygiene requirements. Since the

parts which come into contact with the product have been designed with no gaps and are made of corrosion-resistant stainless steel, this sensor meets stringent hygiene requirements. This allows for safe, hygienic operation and optimized availability of the bottling system.

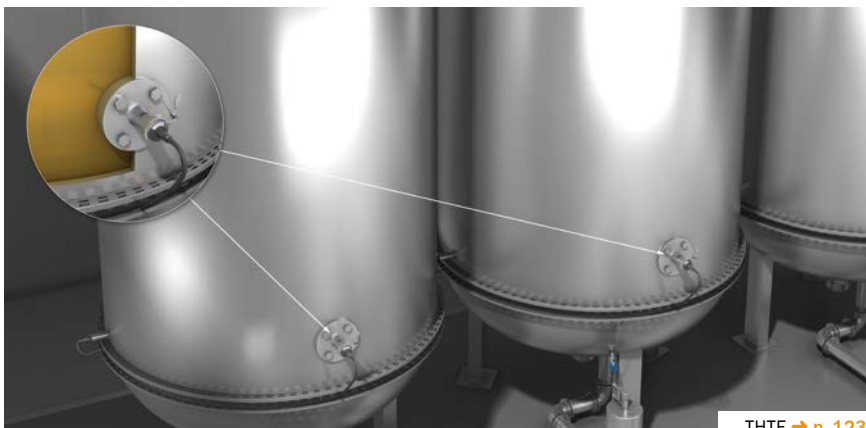

③ Level measurement in storage tanks

Pressure sensors are used to continuously monitor the level of storage tanks in the beverage industry. As the pressure sensor comes into contact with the product, it must be suitable for stringent hygiene requirements. The PBS Hygienic pressure sensor, with its flush-mounted, highly resistant stainless-steel membrane and aseptic process connections, enables safe, hygienic operation and offers exceptional resistance to CIP and SIP processes.





④ Dual determination of the valve position

Dual position determination at valve blocks gives great flexibility at the connection pipes, so there is no need to perform manual coupling or decoupling. Two IMF inductive proximity sensors ideally control the position of the valve. Thanks to its waterproof housing and resistance to aggressive cleaning agents, the IMF is particularly suitable for hygienic areas and wet zones.

⑤ Query of coupling bend position

Coupling panels are used in storage tanks within the beverage industry to control the product flow, and they connect pipes together. The IMF inductive proximity sensor is used to query the position of the coupling bend. Thanks to a sensing face made of metal and a stainless-steel housing thus consisting of one single piece, this sensor is resistant to frequent cleaning, temperature shocks, high mechanical loads, and aggressive media.



IMF → p. 81



IMF → p. 81

① **Measurement of temperature at the heat exchanger of a CIP system**

The temperature in the steam heat exchanger is permanently monitored. Temperature sensors are used to adjust the cleaning temperature. The THTS resistance thermometer has been integrated in the heat exchanger pipes via installation sleeves. Because of this, the sensor can even be replaced during operation.

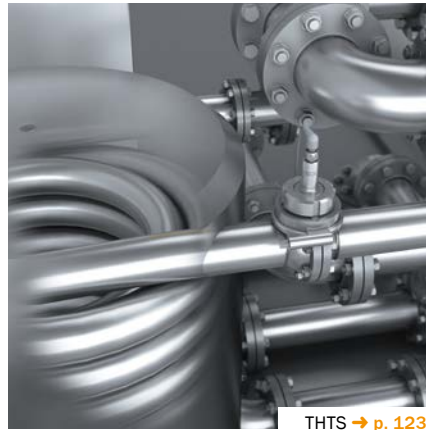

② **Measurement of pressure at the heat exchanger of a CIP system**

The pressure in the steam heat exchanger is continuously monitored. The PBSH pressure sensor, with its efficient evaluation method, is suitable for monitoring the high pressure at the heat exchanger. With its flush-mounted, highly resistant stainless-steel membrane and aseptic process connections, it enables safe, hygienic operation. It is fitted with one analog output and/or two switching contacts, with an IO-Link as an option.



③ **Measurement of flow in the CIP system**

Flow measurements in CIP systems are important for dosing exactly the right amounts of chemicals needed in the different cleaning phases. The DOSIC® ultrasonic flowmeter reliably measures conductive and non-conductive liquids up to a medium temperature of 143 °C. A display and pushbuttons facilitate user-friendly sensor setup. With its all-stainless-steel housing and EHEDG design, the DOSIC® helps to improve the performance and reliability of the entire CIP process.



④ **Measurement of pressure in the feed of a CIP tank**

The feed pressure is decisive when it comes to effective cleaning, for example. A pressure sensor measures the current value and transmits it to the control, which adjusts the pressure to the target value. The PHT pressure sensor is a pressure transmitter that complies with hygiene requirements. Thanks to its flush-mounted, highly resistant stainless-steel membrane and aseptic process connections, it is ideal for hygienically demanding applications in CIP systems.





⑤ Measurement of temperature in the feed and return of a CIP system

Before the CIP media from the containers get into the system, various process steps have to be carried out. First, a heat exchanger heats the cleaning agent to the right temperature. For monitoring purposes, the temperature of the agent is first measured in the feed, then again in the return. The TBT temperature sensor performs this measuring task. It is easy to integrate into the system even in confined spaces and various configurations are possible to meet individual requirements.



TBT → p. 122

⑥ Level monitoring of the CIP storage container

Continuous monitoring of the level in storage containers for water, batch water, sodium hydroxide solution, nitric acid, and cleaning agents is vital. The LFP Inox level sensor reliably differentiates between liquid media, foaming, and deposits. The data obtained is accurately visualized via the HMI. Thanks to FDA-compliant materials, an EHEDG-certified design, and CIP and SIP resistance, the LFP Inox is suitable for applications with stringent hygiene requirements.



LFP Inox → p. 118

⑦ Point level monitoring at CIP storage containers

Point level monitoring at CIP storage containers is done by level sensors, which perform accurate empty and full detection processes at the storage container. The LFPV200 vibrating level switch is the right choice here. It is wear-free, maintenance-free, and can take measurements in a huge variety of liquids. The housing has a particularly high surface quality and aseptic process connections.



LFPV200 → p. 118

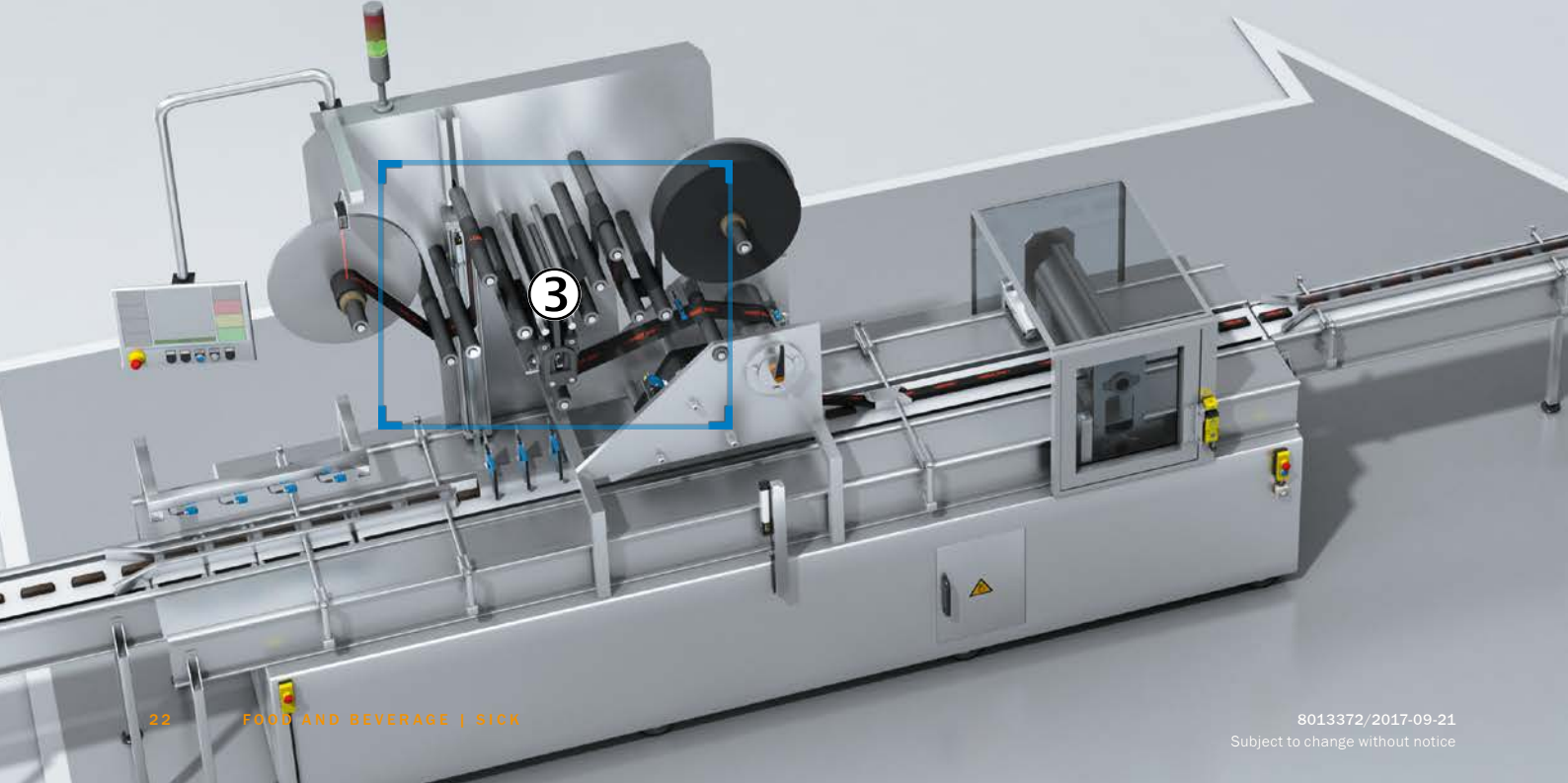
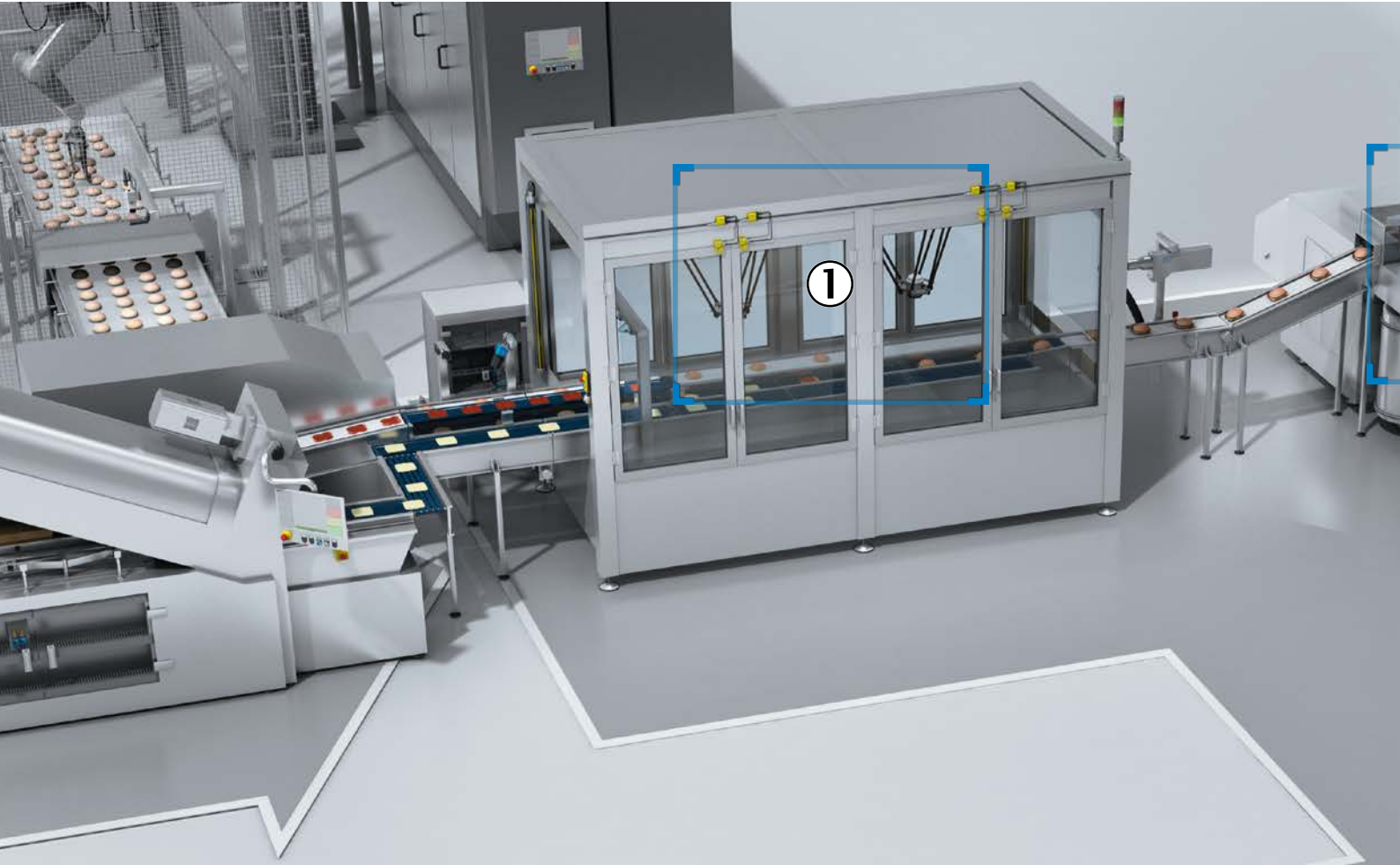



Primary food packaging

Focus 1	24
① Delta picker	
Focus 2	26
② Thermoform, fill, and seal machine	
Focus 3	28
③ Horizontal form, fill, and seal machine	

① Product detection in a hygienic environment

Typical tasks for monitoring and controlling the flow of products in packaging machines are the counting of objects or the resolution of a downstream camera. With SICK sensors, this is easy even in environments with demanding hygiene requirements. The GR18 Inox photoelectric proximity sensor with cylindrical stainless-steel housing is particularly suitable for these tasks and can be integrated into the machine easily.

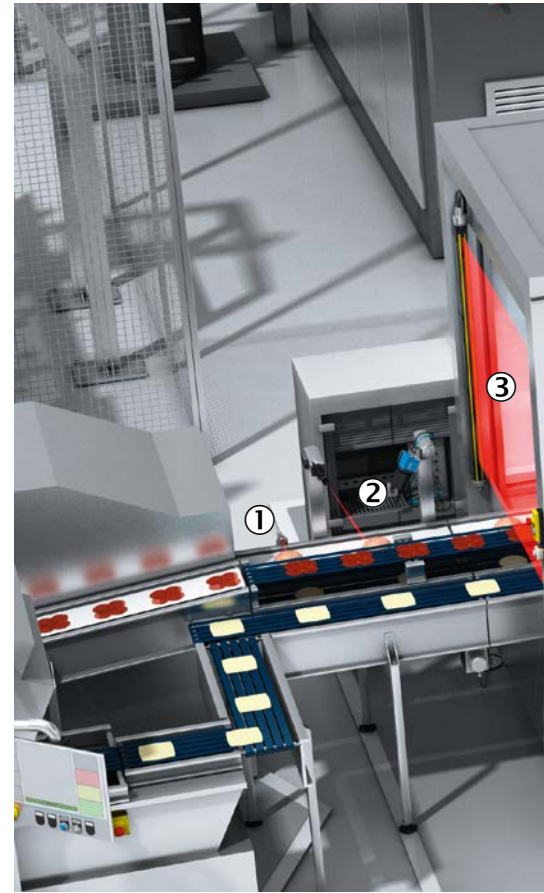

② Quality control of sesame sprinkles

Consumers expect baked goods to be of a consistent quality. Product costs depend to a large degree on expensive ingredients such as sesame, so the seeds need to be counted. The Ranger 3D cameras detect the smallest details for inspection. Complex 3D image processing is performed by SICK AppStudio engineering software, which features powerful libraries, in conjunction with the SIM4000 Sensor Integration Machine.

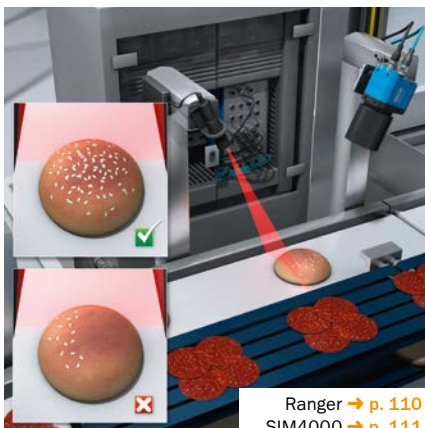

③ Hazardous point protection in a hygienic environment

The deTec4 Core IP69K safety light curtains enclosure rating protect hazardous points in a hygienic environment. Rugged material, smooth surfaces, and a resistance to high-pressure cleaning help to prevent the accumulation of bacteria – an important requirement for use in the food industry.



④ Position detection of products on conveyor belts

If a Delta robot adds cheese or sausage to a roll, it has to grip the goods exactly and reliably. This safeguards quality and reduces unplanned machine stoppages. The Inspector PIM60 2D vision is suitable for checking products and detecting their position on the conveyor or belt. The sensor transmits the data obtained to the robot, which is then able to approach the objects accurately.

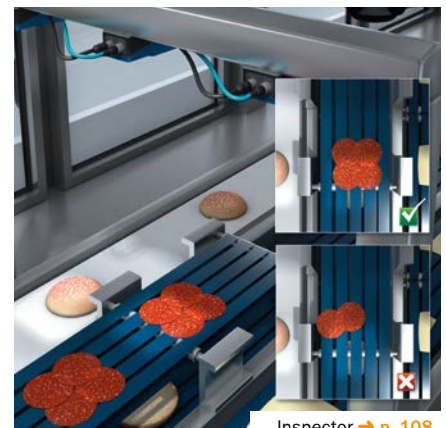



⑤ Check of volume, shape, and dimensions

Achieving a minimal number of defective products is very important in food production. The volume, shape, and dimensions of bread rolls and fillings must be monitored in order to safeguard maximum quality. Inspections performed

by the IVC-3D 3D vision sensor and the flexible IVC Studio software supply values irrespective of contrast or color. This optimizes the process and reduces the number of defective products.

⑥ Control of transport speed in a hygienic environment

The controlled transport of products is important for stable processes within machines. The DFS60 Inox incremental encoder generates accurate speed signals to control belt transport appropriately. The rugged encoder mechanical system is easy to mount. With its high enclosure rating and stainless-steel housing, the encoder is also suitable for use in environments with demanding hygiene requirements.



IVC-3D → p. 109



DFS60 Inox → p. 100

① Packing and storing in inert gas – For optimum freshness and taste

Modified atmosphere packing (MAP) and storage in a controlled atmosphere (CA) are common methods of keeping foods such as fruit, vegetables, or baked goods tasting fresh and preserving their natural color for longer without the addition of preservatives or stabilizers. The controlled and resource-saving use of inert gases reduces the oxygen content and prevents oxidation and hydrolysis. With TRANSIC Extractive or TRANSIC100LP (in-situ), SICK offers analyzer systems for measuring the oxygen concentration continuously. Thanks to their modular design, the TRANSIC variants can be easily adapted to a wide range of requirements and are always simple to install, handle, and maintain.

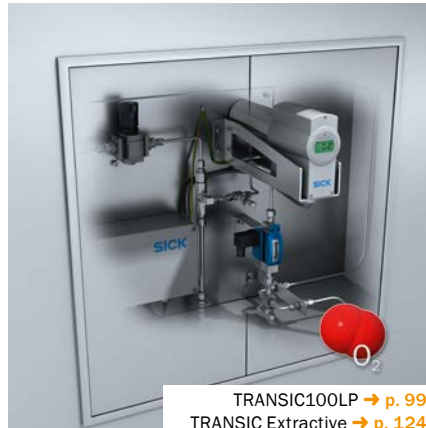

TRANSIC100LP → p. 99
TRANSIC Extractive → p. 124

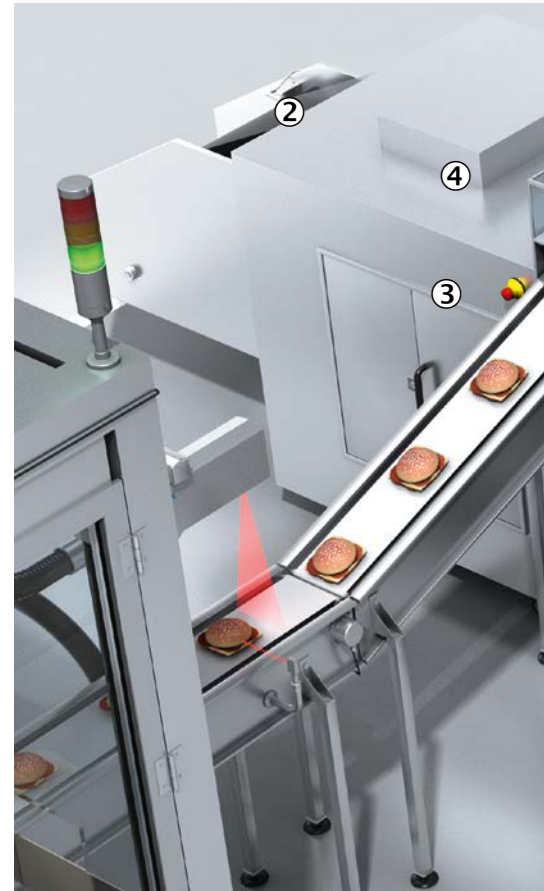

② Detecting end of film reliably

An adhesive strip is attached before the end of the film to let the operator know the roll will need to be changed soon. This is a reliable and simple method of automating the supply of film as an alternative to detecting the diameter of the roll. Depending on the material, an IME inductive proximity sensor can reliably detect metallic strips and a CSM color sensor can detect colored ones.



CSM → p. 84
IME → p. 82

③ Deep drawing product trays perfectly

Product trays are thermoformed using a vacuum and tools, depending on their size. These tools are often operated pneumatically. A stable pneumatic pressure is needed to produce perfectly formed plastic films. The PAC50 pressure switch offers user-friendly functions for reliably monitoring the operating pressure. Two precisely adjustable switching points facilitate stable pressure control.



PAC50 → p. 120

④ Tempering molds and tools

Plastic films are deep drawn by drawing and pressing the warm film onto a cool mold. This mold must be tempered for the process with liquid accordingly. The TCT temperature sensor offers high measurement accuracy in the corresponding temperature range and a compact design for correct measurements in the liquid cycle.



TCT → p. 122



⑤ Monitoring of filled trays

Ensuring that plastic trays are sealed correctly is crucial for the integrity of the packaging. The shelf life of perishable foods in particular directly depends on how the packaging is sealed. The TriSpector1000 3D vision accurately inspects the filled tray and reliably detects the volume of the tray filling, product residue on the edge of the tray, or an incorrect tray shape.

⑥ Tears in transparent films

A constant supply of sealing film, which is often transparent, is vital for a continuous packaging process. In order to optimize machine availability, the WLG4S-3 photoelectric proximity sensor easily detects transparent films in front of a matte stainless-steel sheet. The sensor is just as reliable when it comes to detecting tears in the film; if one is identified, the sensor triggers a machine stop in order to prevent any resulting faults.

⑦ Reliable code reading

Codes and use-by dates are added to packaging containing perishable foods in order to ensure it can be identified and seamlessly traced. Lector63x image-based code readers detect a wide variety of codes and fonts at high read rates. The variable optics and flexible functionality mean they can be used universally.



TriSpector1000 → p. 109



W4S-3 Glass → p. 74



Lector63x → p. 105

① Determining the wrapping diameter

The speed of the film can be controlled using a brake or a drive, depending on the diameter of the roll. Despite the variable diameter, this means the sheet speed and tension remain constant, so as to ensure the packaging film is fed in evenly. The OD1000 distance sensor reliably records the diameter and generates accurate measured values with a high degree of linearity.



OD1000 → p. 112



② Detection of dancer position

A dancer serves to compensate for irregularities when unwinding the packaging film and to apply a constant sheet tension for the infeed process. To do this, the dancer position is regulated to its center position. The attached MPA position sensor accurately detects any deviations from this position. The film then runs precisely, with the correct tension, and defects such as those that can arise when sealing flow packs do not occur.



MPA → p. 83

③ Double layer detection when splicing

Highly productive packaging processes require a continuous supply of film. Flying roll changes with the machine running help here, as the films are spliced automatically within fractions of a second at a certain point. If a double layer is produced at the splicing point, this must be identified so it can be rejected later. The UD18 ultrasonic sensor reliably detects double layers and identifies the position being sought quickly and accurately.



UD18 → p. 115

④ Accurate edge guiding

To achieve consistent packaging quality and sealing of flow packs, the packaging film must be run optimally through the bagging machines. The Ax20 array sensor precisely detects the edge of a wide range of films. The analog measurement signal reliably regulates sheet control through the machine. The visible light spot also enables accurate adjustment without additional settings.



Ax20 → p. 86

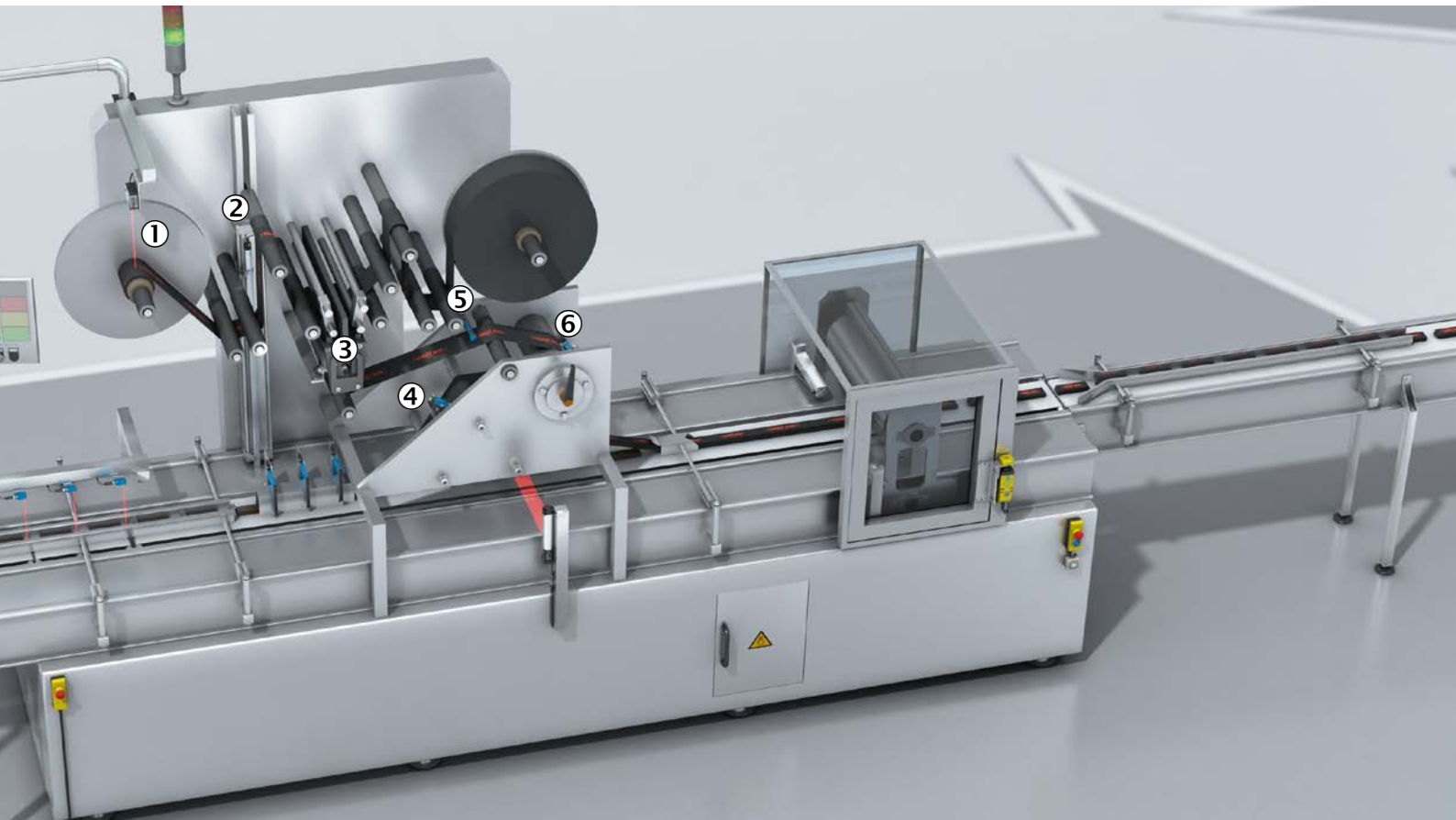

⑤ Detection of film tears in transparent materials

To ensure a reliable feed of packaging film, the material must be checked continuously to verify that it is still present. The bonded splicing point can become detached, particularly after a flying roll

change. The compact UF fork sensor reliably detects a huge variety of films, irrespective of their optical characteristics.

⑥ Reliable print mark detection

Print marks help to position packaging materials correctly in automated production processes. The KTM Prime contrast sensor detects these marks reliably in order to register the film seal correctly. The stainless-steel variant meets even very stringent hygiene requirements. A special mounting system minimizes the risk of contamination.

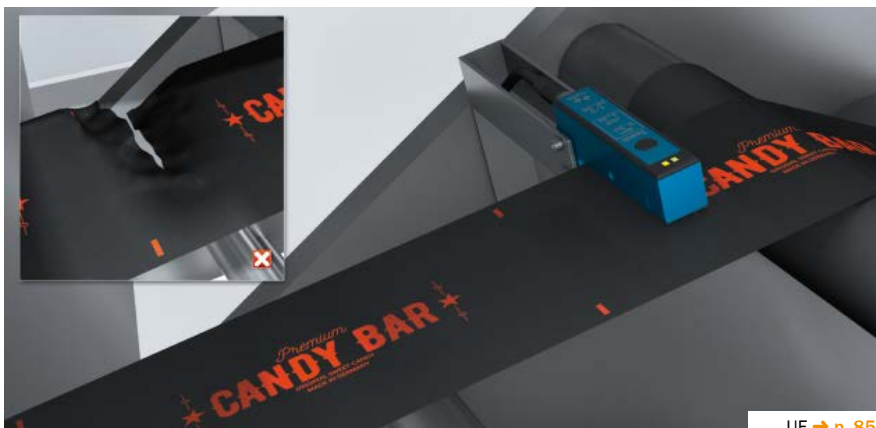

UF → p. 85

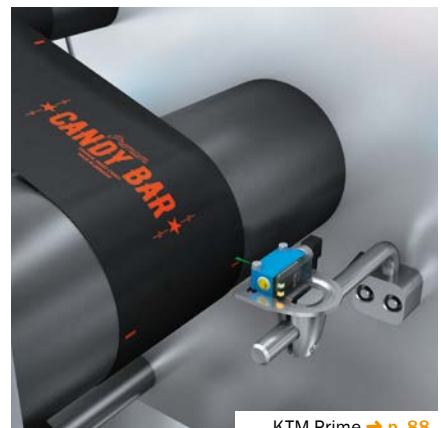

KTM Prime → p. 88

⑦ Equidistant infeed of products

Products are fed into the packaging process at exactly equal intervals, so the packs can be closed and products singulated without a hitch, even at high cycle rates. To do this, photoelectric proximity sensors detect the products on the transport belts and determine their exact position. By detecting products quickly and accurately, the compact WTB4-3 photoelectric proximity sensor guarantees trouble-free operation and maximum productivity.

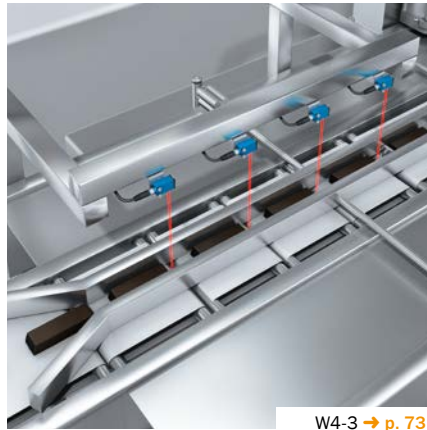

W4-3 → p. 73



⑧ Check of product height

The right product height ensures that a product will not collide with parts of the machine and will fit into the packaging. Sometimes products lay on top of one another incorrectly. WF fork sensors are installed on the transport path accordingly, in order to accurately detect these differences in height.



WF → p. 86

⑨ Reliable detection of irregular product edges

The exact detection of product edges in the packaging process avoids collisions. Irregular product shapes present a huge challenge here. Single light beams alone can easily miss irregular edges, which can lead to defective packaging. The MLG-2 Prime automation light grid or the WL27-3 compact photoelectric sensor reliably detects even flat and small objects, even if they are shaped like wedges, pillows, or pockets.



W27-3 → p. 76
MLG-2 Prime → p. 90

⑩ Safe process locking

Bagging machines use high-speed rotating tools to seal and cut sheet materials once the product has been fed into the system. Access to the hazardous point while the machine is running must be prevented accordingly, by means of a safety locking function on the service door. The TR10 Lock safety locking device provides a high locking force and a rugged design.



TR10 Lock → p. 96

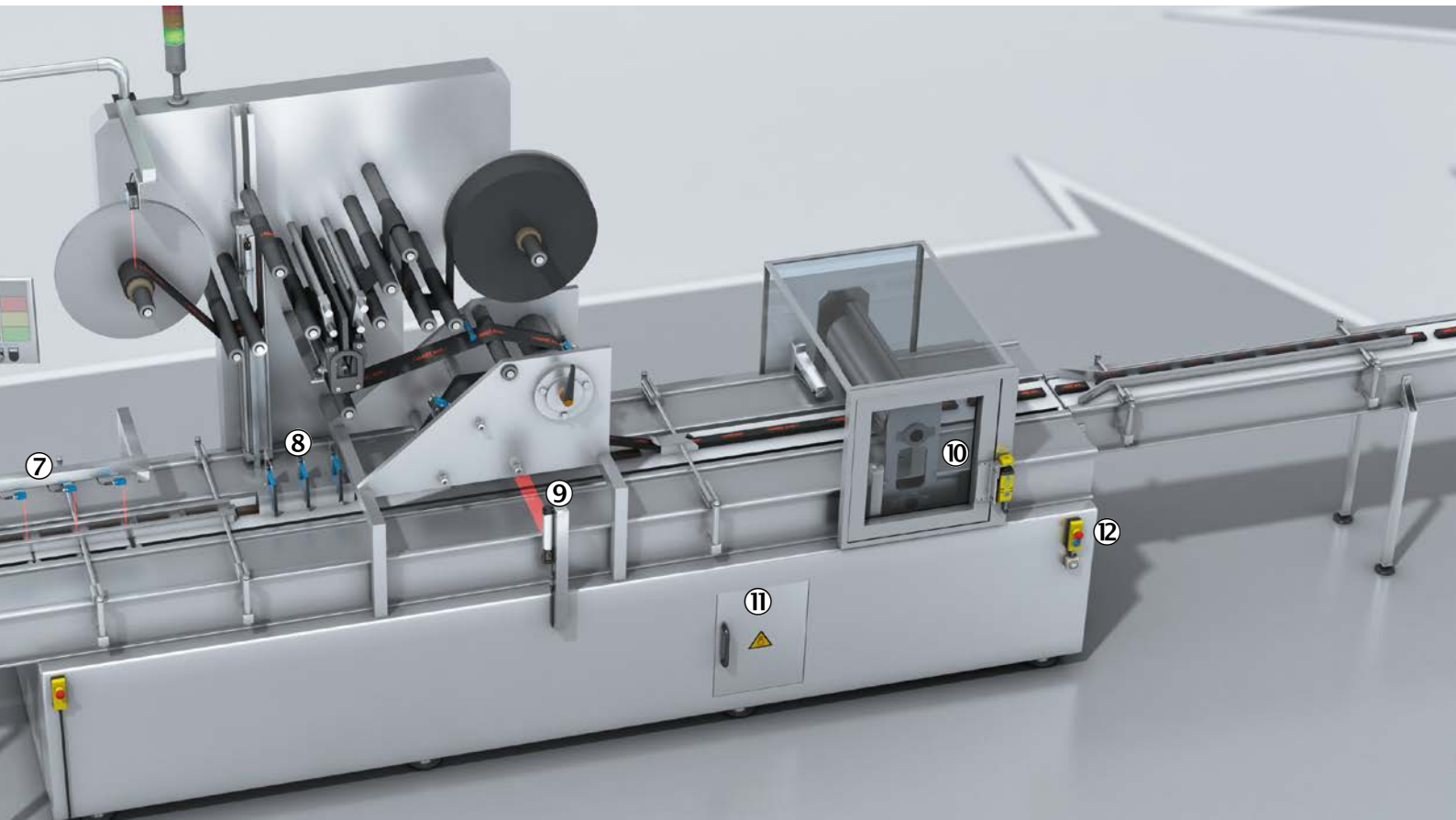

⑪ Protecting the safety doors

Concealed safety switches are attached in order to safely monitor safety doors when the machine is running. The RE1 magnetic safety switches are a reliable and economical solution. Even on simple doors and when there is contamination, these coded switches work reliably up to safety level SIL3 and PL e.

⑫ Safe machine linking

Complex packaging lines need machines to be linked safely and flexibly. Cascading safety switches and sensors with OSSD outputs via Flexi Loop minimizes the amount of wiring and the number of inputs at the Flexi Soft safety controller, thus lowering costs. Flexi Link is an ad-

ditional function of Flexi Soft. It provides a network solution with straightforward configuration and rapid commissioning. Both safe connections offer maximum flexibility without complex addressing procedures.



RE1 → p. 95

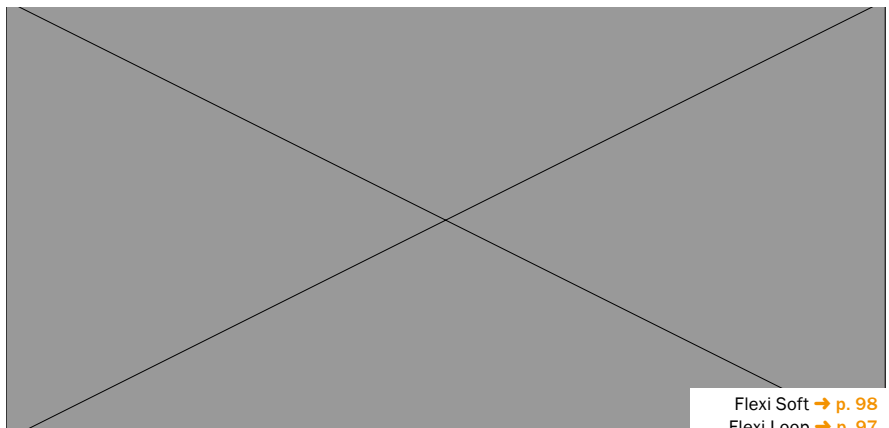

Flexi Soft → p. 98
Flexi Loop → p. 97

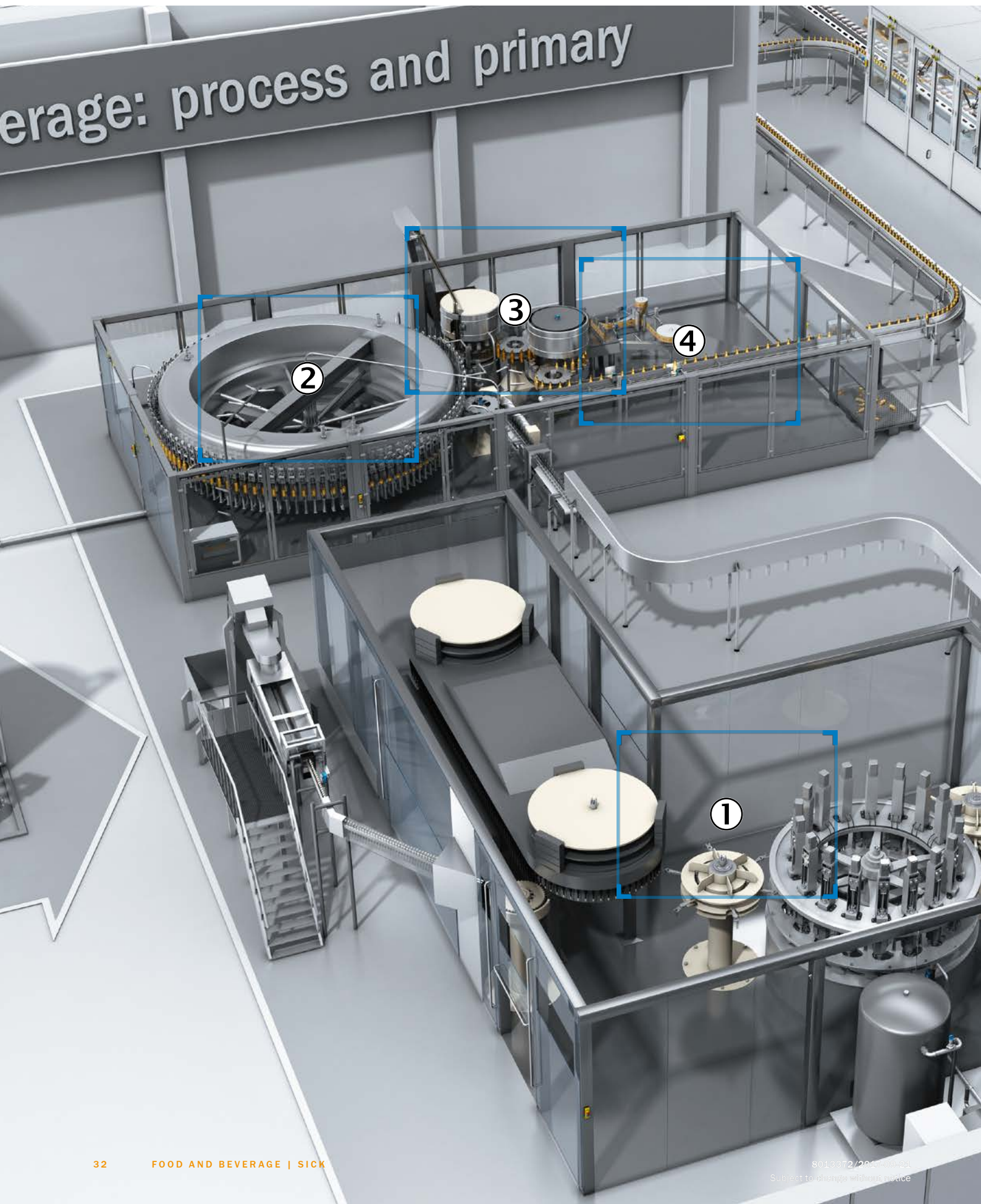



Primary beverage packaging

Focus 1	34
① Blow stretching machine	
Focus 2	36
② Filler	
Focus 3	38
③ Cap feeder and capper	
Focus 4	40
④ Labelling machine	

① Quality control of preforms

The quality of plastic bottles depends on the blanks, also known as preforms, having the correct shape and dimensions. A consistently high quality is required in order to optimize process availability. The Inspector PIM60 2D vision sensor quickly checks objects using various inspection tools; used in conjunction with the variable integrated IR or UV illumination, it creates an effective application solution.



Inspector → p. 108



② Detection of carousel position

The carousel angle of rotation serves to control the transport of bottles through the blow stretching machine. A high-precision AFM60 EtherCAT® absolute encoder, which precisely synchronizes the rotations electronically, supplies the

absolute angle. Its optimized mechanical system makes it easy to mount in a central position. Linear and rotative movements are coupled together via electronic cams.

③ Detection of discrete mechanical positions

If discrete mechanical positions are detected, this enables complex blow modules to be handled easily on a blow carousel. Electronic cam switches are realized via rugged IQG inductive proximity sensors.



AFS/AFM60 EtherCAT® → p. 102



IQG → p. 82

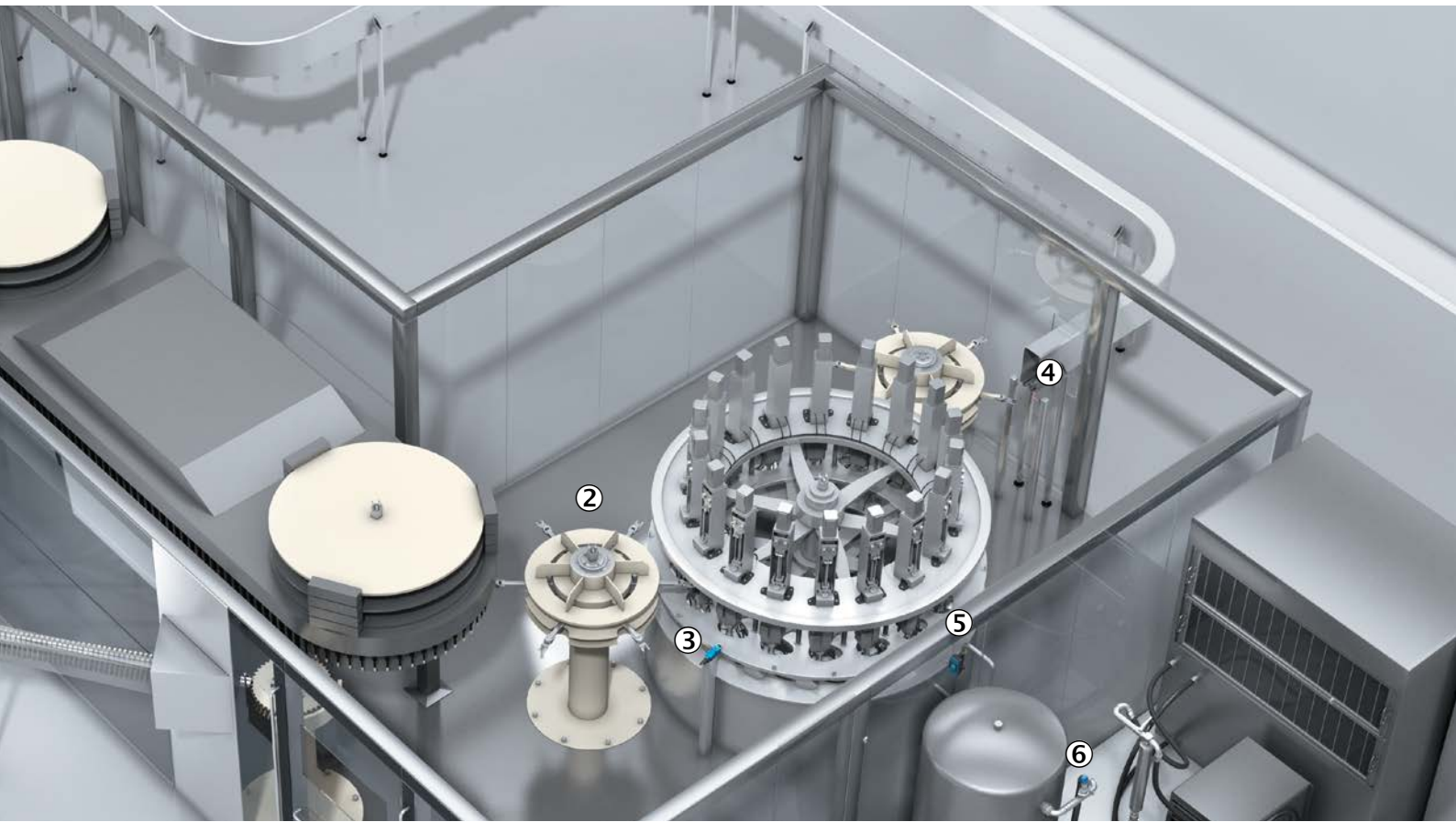

④ Transport of transparent objects

High cycle rates are standard in bottle production. Objects need to be reliably detected if fast, smooth transport is to be achieved. The high speed and critical optical characteristics of drinks bottles require precise detection. The W9-3 Glass small photoelectric sensor detects transparent objects in demanding applications reliably and quickly.

⑤ Tempering of blowing molds

It is important to control the temperature of blowing molds if PET bottles are to be formed reliably. The metal molds are tempered with liquid to ensure bottles will be formed correctly. The FFU flow sensor provides optimum process stability for the thermal procedure.

⑥ Supply of compressed air in the blowing process

The blowing process is critical for forming plastic bottles correctly. As a result, the pressure needs to be precisely maintained during the forming procedure. The PBS Hygienic pressure sensor is able to measure high pressures reliably. This ensures that the compressed air required for the process is available.



W9-3 Glass → p. 75



FFU → p. 121



PBS Hygienic → p. 119

① Level measurement in buffer tanks of bottling systems

Measurement of the buffer tank level in bottling machines is an important aspect of supplying liquid to the bottling system. The LFP Inox level sensor reliably differentiates between liquid media and foaming. Using FDA-compliant materials, EHEDG-certified design, and CIP and SIP resistance, the LFP Inox is suitable for stringent hygiene requirements.



LFP Inox → p. 118



② Measuring the level of the bottle

Having the right level of liquid in a bottle is a fundamental product feature; the level is best read from the liquid in the neck of the bottle. WLL180T fiber-optic sensors are particularly well suited to this task, since they have excellent detection properties when it comes to transparent objects. They are mounted on the level probe directly to facilitate optimum detection.



WLL180T → p. 78

③ Pressure measurement in buffer tanks of bottling machines

When carbonated beverages are bottled, pressure must be applied so that no foam is produced and precise process control is possible despite the high throughput. The PHT pressure sensor with a flush-mounted, hermetically sealed stainless-steel membrane and sterile process connections is the ideal pressure transmitter for hygienic applications in the beverage industry.



PHT → p. 120

④ Synchronization of infeed systems

If bottling systems are to deliver high availability, they require a continuous supply of bottles. The infeed is therefore synchronized with the rotation of the ring tank. Several AFM60 PROFINET absolute encoders on the carousel and the conveying line control the infeed speed and product position, thus avoiding collisions.

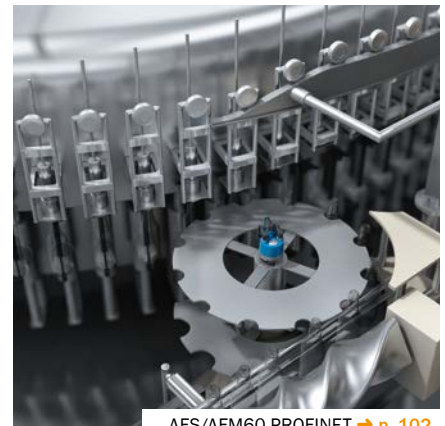

AFS/AFM60 PROFINET → p. 102

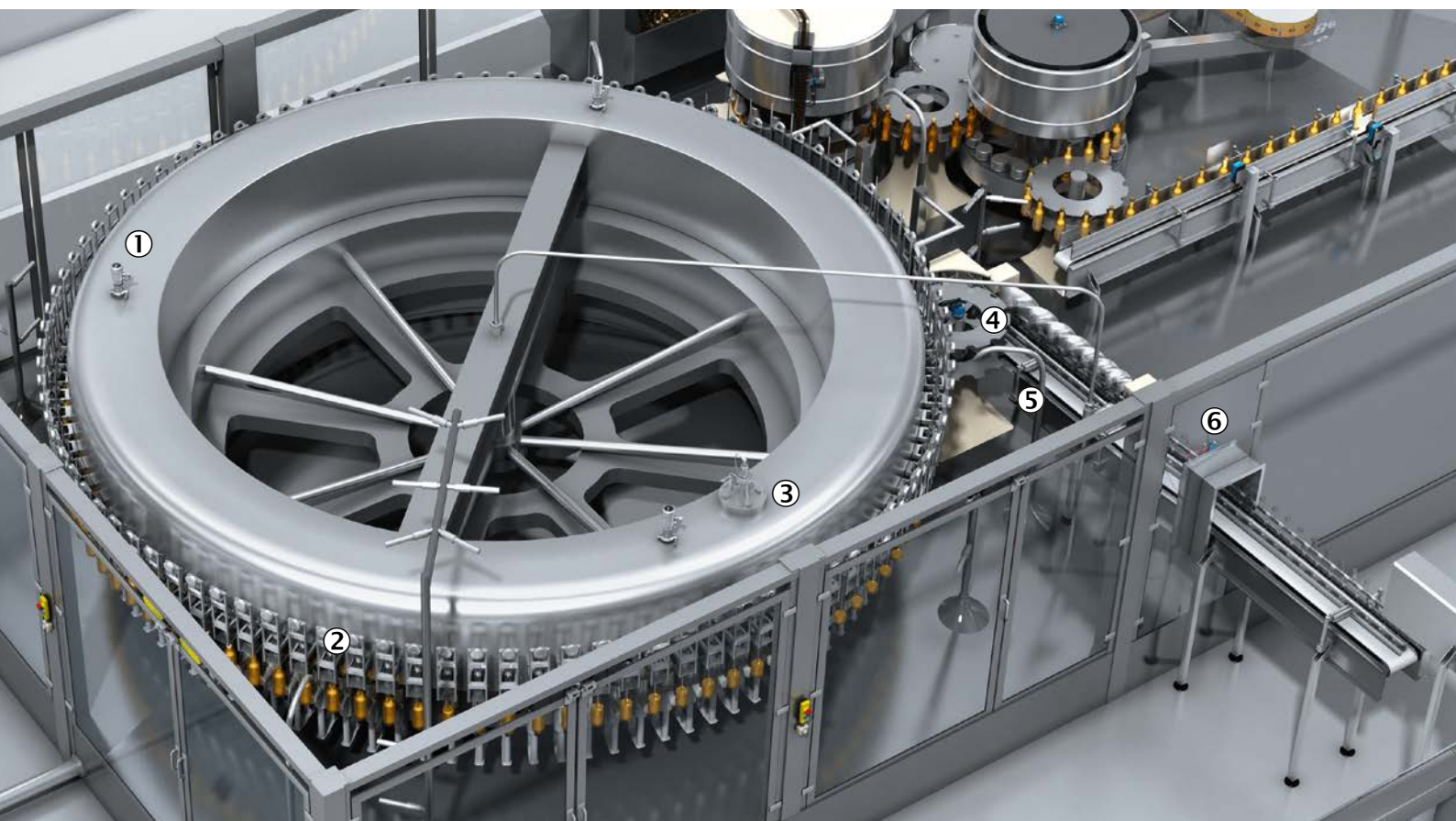

⑤ Flow measurement of the medium

If a sufficient supply of filling liquid is always available, this will ensure that bottling is performed correctly. To this end, the ring tank in the machine is constantly being topped up. Modern flow measurement using sensors from SICK enables the filling process to be controlled precisely. The DOSIC® ultrasonic flowmeter is particularly suitable for this task thanks to its special measurement technology in a hygienic design with no sensor in the flow path.

⑥ Detection of transparent objects without the use of a reflector

A typical application in bottling systems is the counting of bottles at the infeed and outfeed of the filler. The TranspaTect MultiTask photoelectric sensor reliably detects transparent and semi-transparent objects without a reflector. Just a matte machine wall provides the reference surface. TranspaTect is not sensitive to contamination, thus guaranteeing maximum machine availability.



DOSIC® → p. 121

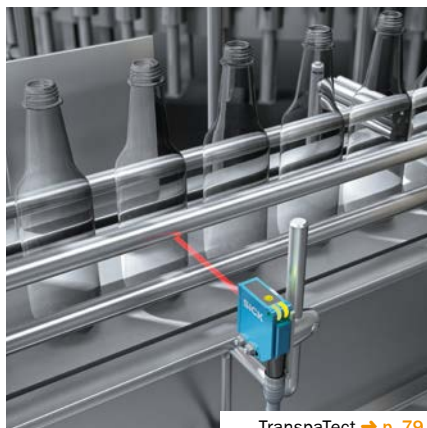

TranspaTect → p. 79

① Quality control of bottle caps

Every filled bottle must be checked to ensure it has been sealed correctly and to the right level of quality. The Inspector 2D vision is flexible, able to check the position of any cap used and its screw position, and to detect screw errors. It is also easy to configure the switchover between different bottle caps.



Inspector → p. 108

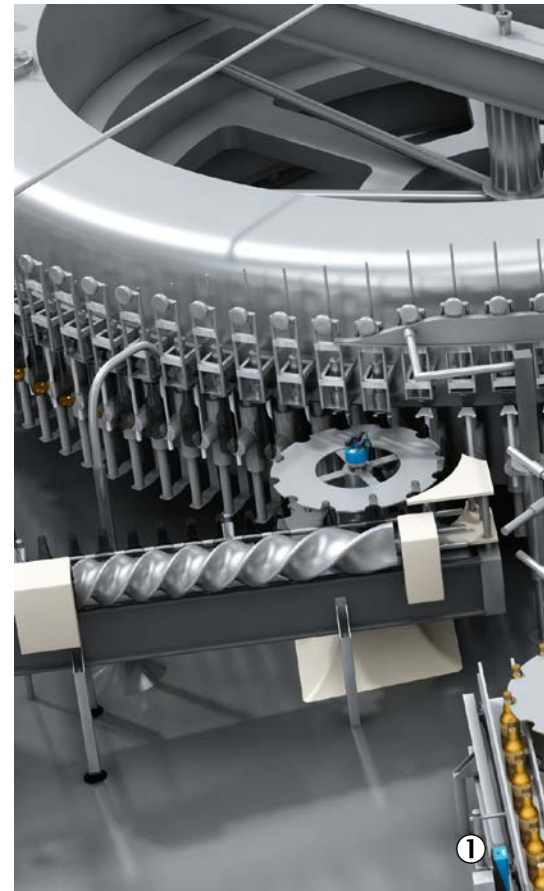

② Color monitoring of caps

Ultimately, what a product looks like is crucial in making it attractive to buyers. Therefore, caps with incorrect colors must be rejected. The CSM color sensor from SICK detects even tiny color differences and so guarantees a consistent appearance, e.g., of bottles in a container.

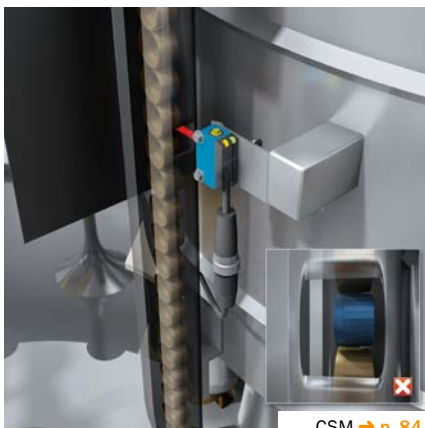

CSM → p. 84

③ Position of caps during infeed

The high cycle rate employed when feeding in caps calls for very fast response times. Two coordinated W2SG-2 miniature photoelectric sensors reliably check the position of the caps by detecting the cap profiles. Since both sensor signals are logically processed directly, incorrect caps can be detected and rejected quickly.

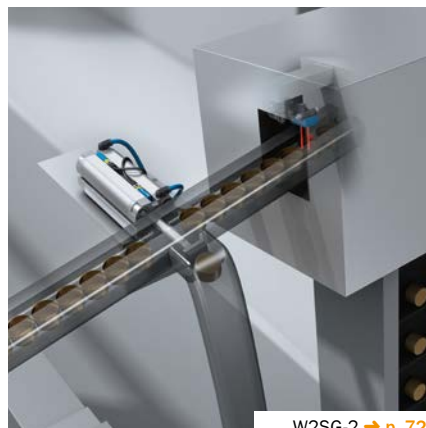

W2SG-2 → p. 72

④ Safe process locking

Locking devices provide safety, enabling plants to be operated efficiently, and prevent unwanted machine downtimes. The TR10 Lock safety locking device and Flexi Loop safe sensor cascade offer connection technology with diagnostic capabilities and a performance level up to PL e. Used in conjunction with the Flexi Soft safety controller, Flexi Loop makes safe machine logic user-friendly and reduces wiring requirements with simple M12 cables.



Flexi Loop → p. 97
TR10 Lock → p. 96

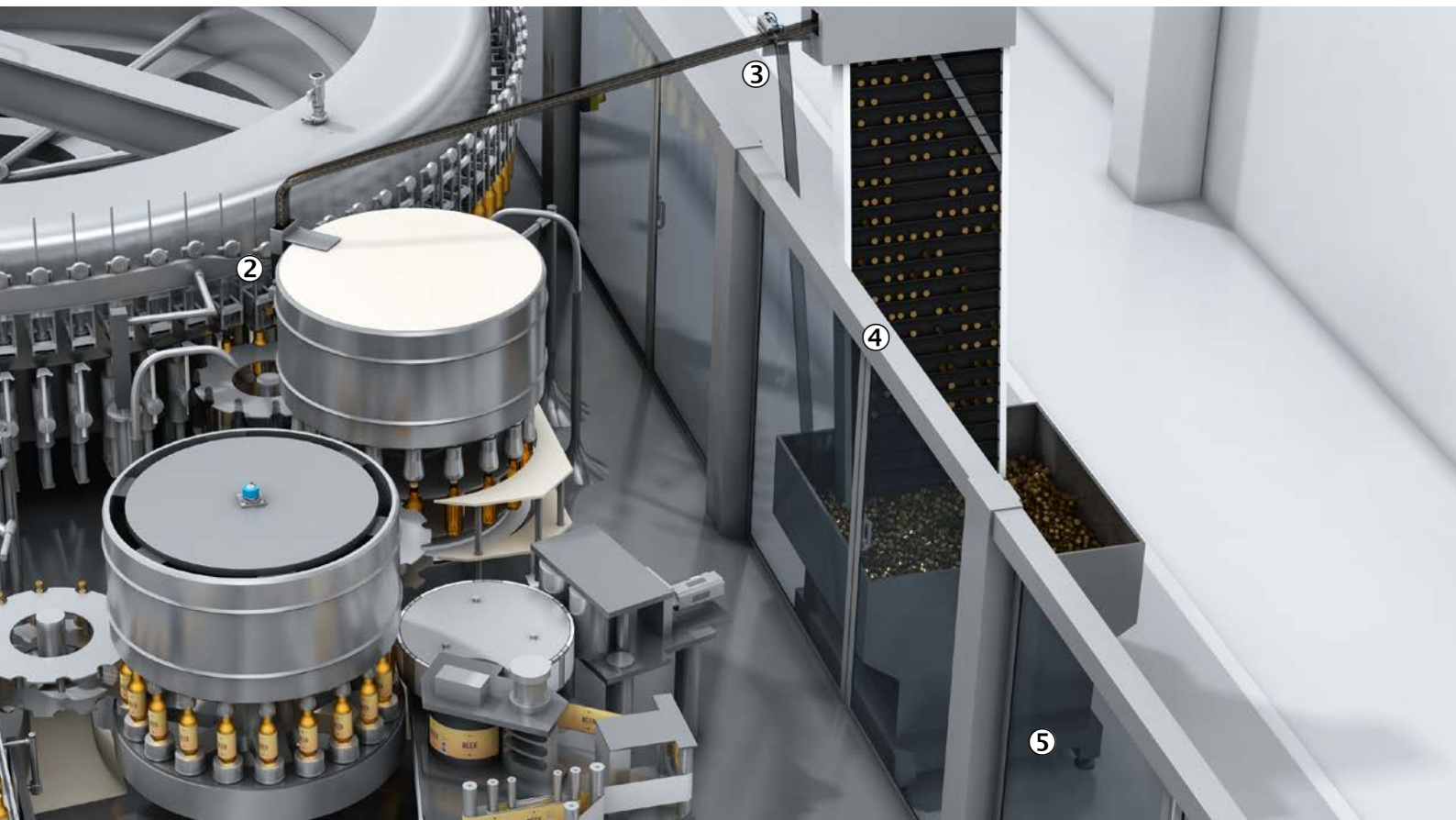

⑤ Monitoring of stock of bottle caps

One important aspect of ensuring high productivity on the bottling line is to make sure there is a continuous supply of bottle caps. To this end, the caps are detected in the infeed hopper. The CQ35 capacitive proximity sensor is easy to attach to the outside of the hopper, is able to detect the presence of caps through the metal, and indicates the point level really visibly.

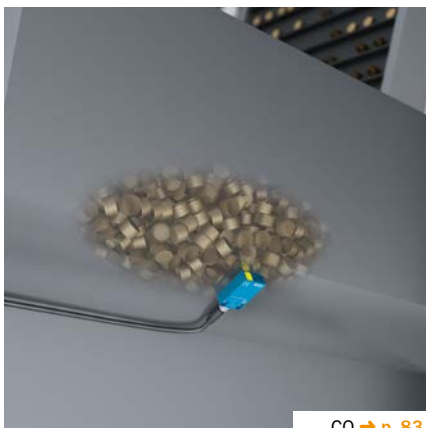

CQ → p. 83

① Speed detection for correct labeling

The process of dispensing labels is synchronized with bottle transport, to ensure the label is attached smoothly and in the right place. The labeling module needs to have exact measured values relating to the movement so it can deal with machine startup and variable production speeds. The DFS60 incremental encoder is easy to mount and generates high-precision speed and position values.



DFS60 → p. 101



② Check of the label once applied

The label provides customers with information about the product and acts as an advertising platform too. Therefore, the programmable InspectorP632 Flex 2D vision checks for presence, position, and contents, e.g., product codes and symbols. The integrated web server provides a perfect overview of the functionality and inspection results via Ethernet.



InspectorP63x → p. 108

③ Cutting of continuous labels without print marks

Continuous labels for bottles must be cut in exactly the right place before they are applied. The PS30 pattern sensor locates the cutting position precisely without print marks, even at high process speeds of up to 10 m/s. The sensor reads a pattern based only on the contrasts in the printed image and calculates the position sought from that pattern. This opens up a whole new world of design freedom for more attractive labels.



PS30 → p. 89

④ Precise monitoring of unused film

Powerful machines in the bottle filling sector apply up to 60,000 labels every hour non-stop. In order to use up as much of the thin label material as possible, the roll being used must be measured precisely. The high resolution of the DT20 Hi displacement measurement sensor minimizes unused labels and optimally controls the flying roll change via a switching output.

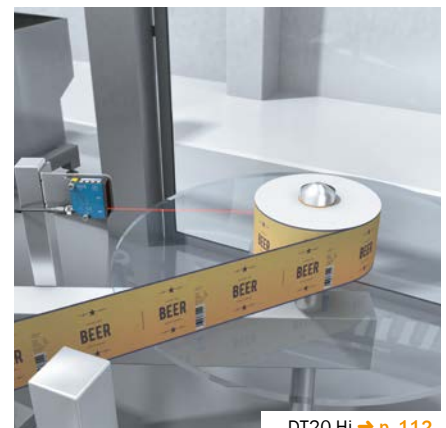

DT20 Hi → p. 112

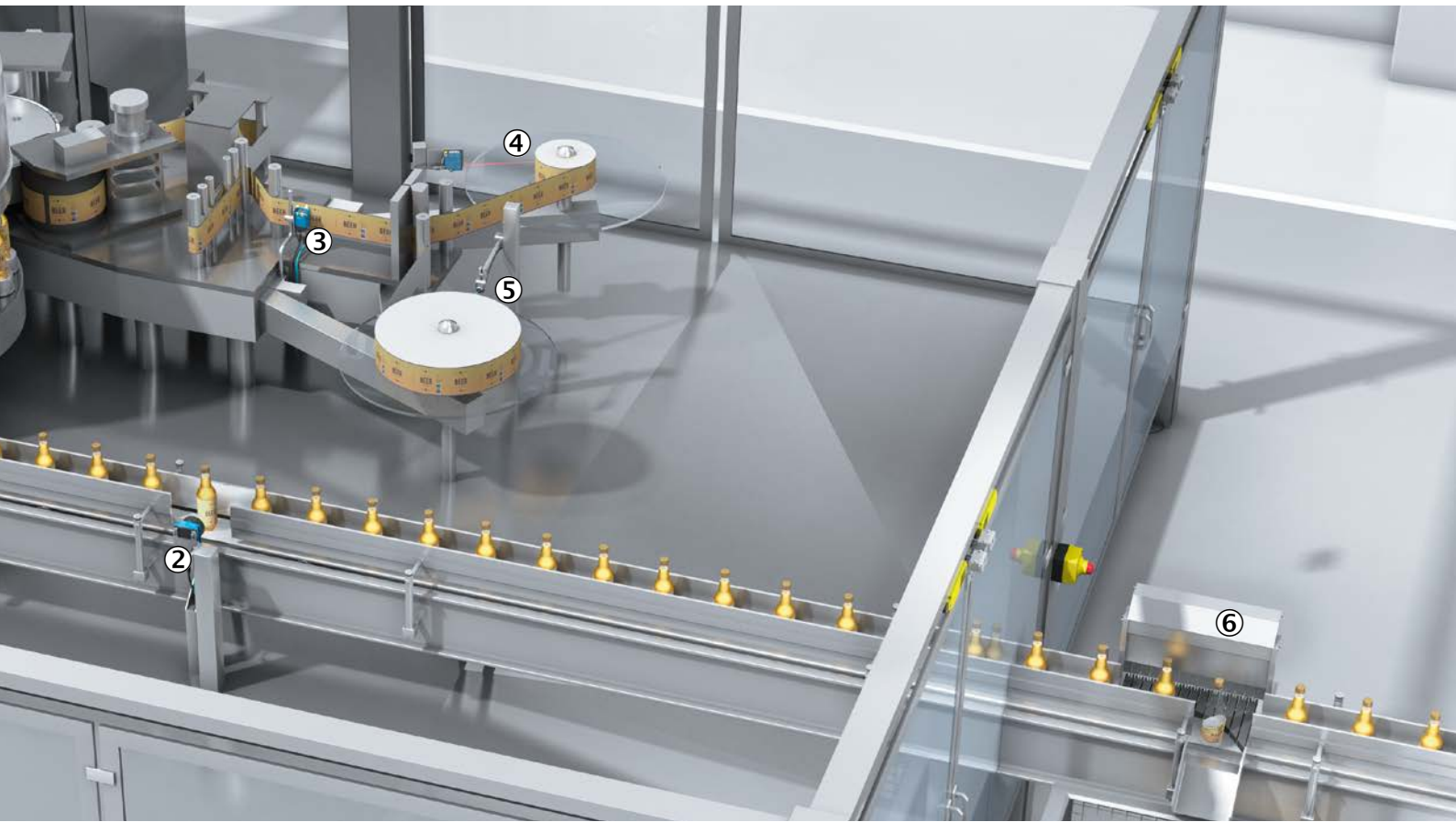

⑤ Diameter monitoring for unwinders

A constant sheet tension is required when unwinding sensitive film material. The diameter of the roll is determined so the discharge of label films can be controlled correctly. Robust ultrasonic sensors from the UM18 product family accurately detect the diameter and switch when defined limit values are reached. In this case, the operator receives an additional signal to change the roll in good time.

⑥ Removal of faulty products

Products identified during the bottling or labeling process as faulty must be reliably removed before they reach the packing stage. MZT7 sensors for T-slots are used on the pneumatic cylinders for this purpose. The small magnetic cylinder sensors monitor the end positions of the cylinder so they can indicate the correct ejection movement.



UM18 → p. 114



MZT7 → p. 84

Packaging: secondary and end-

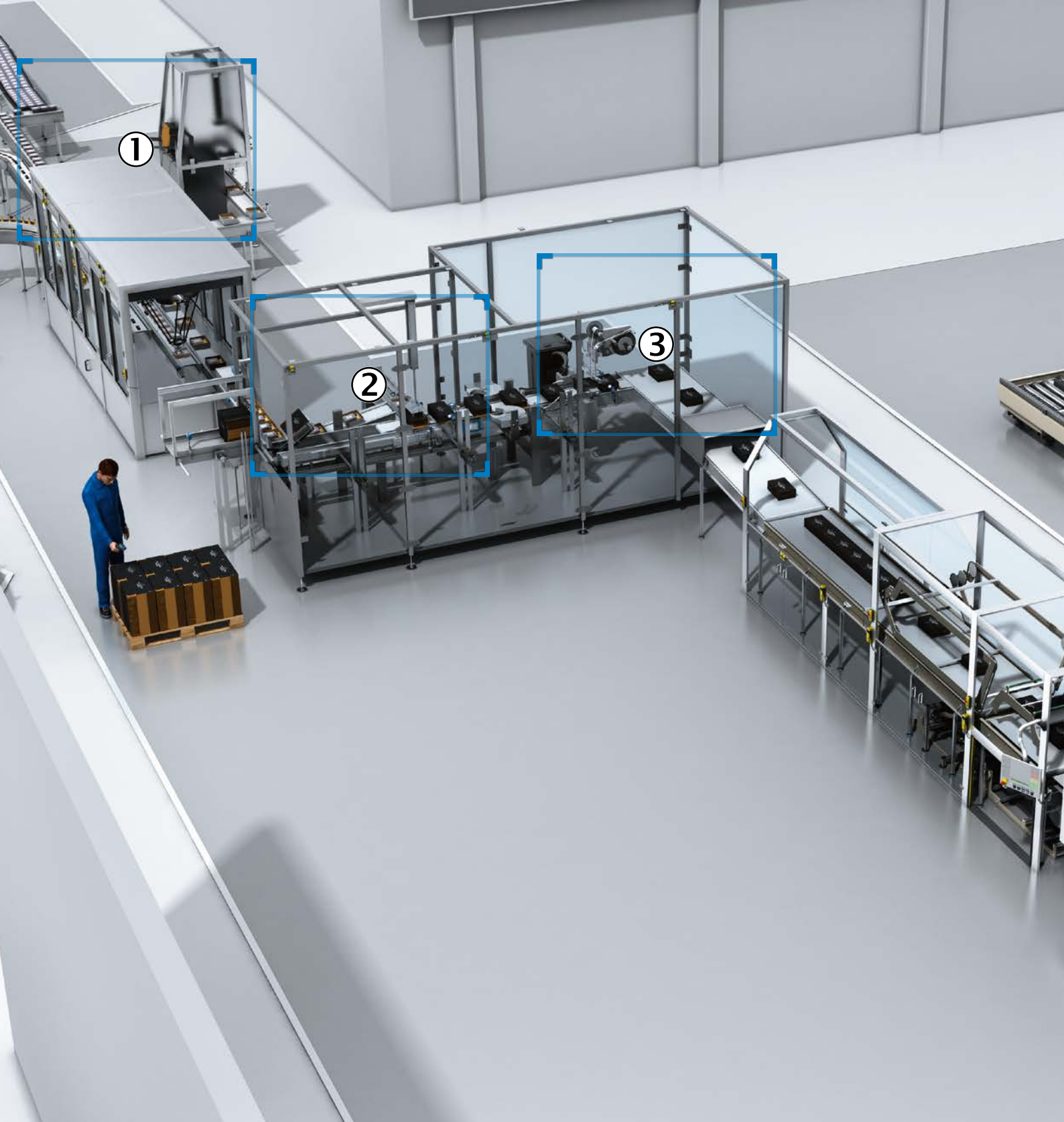



Secondary packaging

Focus 1	44
① Top loader	
Focus 2	46
② Carton erector	
Focus 3	48
③ Side loader	
Focus 4	50
④ Wrapper	

① Counting of products at the infeed

A typical packaging machine application is to monitor and control the flow of products by counting objects. The WLG16 photoelectric retro-reflective sensor detects transparent objects reliably and can be specifically adjusted to the application in question in just two steps using the BluePilot operating concept. Be it films, trays, glass bottles, plastic bottles, or tears in the film, the WLG16 reliably detects everything and maintains a good overview even when contamination is present, thanks to AutoAdapt technology.



W16 → p. 76

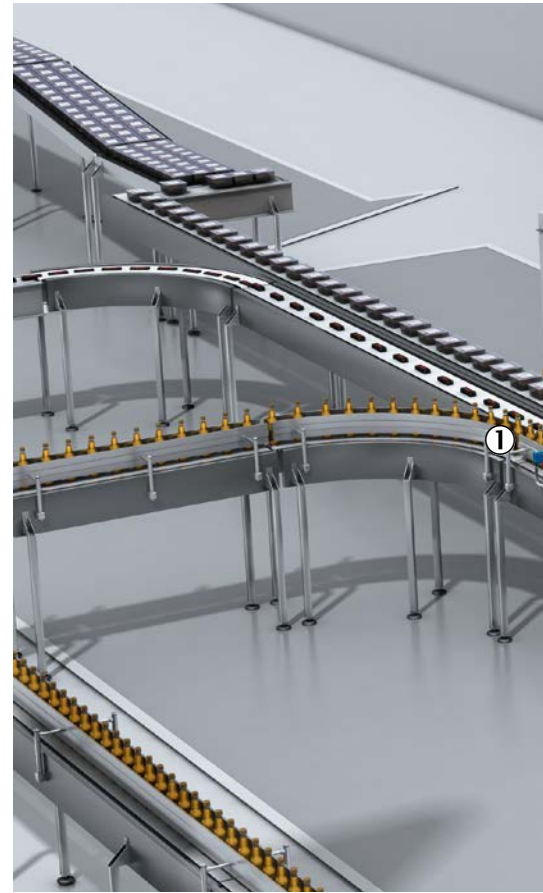

② Monitoring of the pneumatic pressure

The system pressure must be monitored to ensure smooth top loader operation. The PAC50 electronic pressure switch is particularly well suited to this application. Thanks to its three large function buttons and large display, it is easy to use. The color of the digits on the pressure switch display indicates whether the system pressure is within the target range. The optional IO-Link interface of the PAC50 reduces downtimes when changing formats and the sensor.



PAC50 → p. 120

③ Precise position value identification

The 3-axis gantry robot removes a carton from the conveyor belt and supplies it to the next process. Here, it is critical that the movements necessary for positioning within the process are carried out with a high degree of accuracy. The high-resolution AFS/AFM60 EtherCAT® absolute encoder takes high-precision measurements of the absolute position and speed of the conveyor belt. Its other comprehensive functions for diagnosing parameters such as temperature or operating time and early error detection increase network reliability.



AFS/AFM60 EtherCAT® → p. 102

④ Access protection at the top loader

An ES11 emergency stop pushbutton with reset function is attached to the door leading to the top loader. In the case of danger, the pushbutton is pressed and the dangerous movement of the robot is stopped. To prevent unauthorized access to the robot cell, the RE1 magnetic safety switch secures the access door too.



ES11 → p. 97
RE1 → p. 95



⑤ Reliable detection of packaging

Packages being transported on a conveyor belt must be detected and counted reliably. In the past, products had to be singulated for this purpose. The DeltaPac MultiTask photoelectric sensor (WTD20E) detects packages on the conveyor belt even if they are close to each other. It detects the packaging

regardless of their color and surface. This allows for non-contact, wear-free, and reliable counting. With the DeltaPac MultiTask photoelectric sensor, therefore, this separation is no longer necessary. This does away with the need for elaborate mechanisms in the conveying line.

⑥ Check that cartons are completely filled

An incompletely filled carton can lead to recalls and dissatisfied customers. Used as a camera, the TriSpector 3D vision scans moving or stationary forms and detects the volume of the filling or an incorrect carton shape. The three-dimensional image thus created shows whether the carton has been filled completely.



DeltaPac → p. 79



Trispector1000 → p. 109

① Level measurement on a carton magazine

For the packaging machine to be operated continuously, the carton magazine level has to be monitored. The WTB16 small photoelectric sensor is used for this. The sensor, which works according to the scanning principle, achieves stable detection results even on jet-black cardboard packaging and is immune to any type of optical reflection and ambient light. Thanks to the BluePilot operating concept – the 2-in-1 combination of a teach-in button and potentiometer in conjunction with a blue LED display for the sensing range – the sensing distance can be precisely adjusted in seconds.



W16 → p. 76



② Protection of the carton magazine

In the case of packaging machines, and particularly when it comes to material transportation of flat carton blanks, for example, there is a danger of the operator reaching into the magazine to add more material while the machine is running. With Safeguard Detector, SICK provides a certified, all-round functional safety system designed to avoid potential injuries.



Safeguard Detector → p. 126

③ Presence check of carton prior to setting it upright

An exact infeed of the carton blank is important for setting the packaging upright correctly. The reliable drawing in of the blank provides the process stability needed for the high cycle rates of cartoning machines. To achieve accurate detection, therefore, it is advisable to align the sensor precisely on the wall of the carton. Aligning the sensor and

reflector is child's play with the WLA16 photoelectric retro-reflective sensor – thanks to the BluePilot LED alignment aid. There is no longer any need to make any settings at all on the device. What's more, the photoelectric sensor displays a totally stable detection response even on depolarizing objects such as film-wrapped cartons.

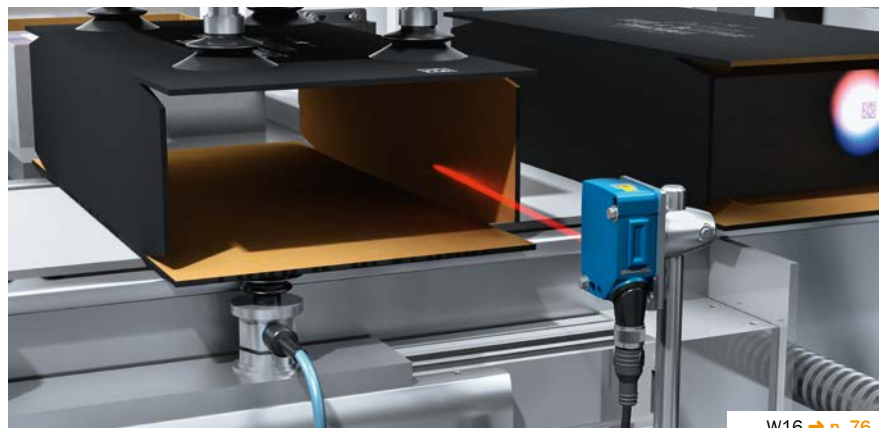

W16 → p. 76



④ Monitoring the position of the setup mechanism

In order to control the fault-free operation of the setup mechanism, it is necessary to monitor the mechanical system. The IME inductive proximity sensor safeguards accurate positioning. It runs reliably thanks to its high shock and vibration resistance, plus it provides a high degree of positioning accuracy in the machine. The most important requirements for inductive sensors are precision, maximum availability, and a long service life, all of which the IME fulfills.



IME → p. 82

⑤ Intelligent and non-contact door protection

The STR1 non-contact safety switch protects safety doors on a packaging machine. The high tolerance of the sensor against door offset and the sensor's diagnostic capability increase machine availability. When used in combination with the Flexi Soft safety controller, safe series connection is possible. This enables the STR1 to issue a stop signal to the machine when a door is opened and to not allow the machine to restart until the door has been closed.



STR1 → p. 95
Flexi Soft → p. 98

⑥ Identification of the cardboard packaging

To ensure that the cardboard packaging inserted into the magazine after a format change matches the new format, it must be uniquely identified. The IDM26x hand-held scanner is used for this. It identifies a very wide range of 1D and 2D code types, plus it can be integrated easily and flexibly via industrial fieldbus networks.



IDM26x → p. 107

① Monitoring the position of the product pusher

The position needs to be determined continuously in order to control the product pusher. The MPA position sensor detects the position of the piston on the pneumatic cylinder continuously, directly, and without contact, thus monitoring the piston path easily and precisely. The sensors in the MPA product family are ideal for large piston diameters and long strokes. The sensor settings can be adjusted during installation and during operation later on, using a teach field or – depending on the variant – using IO-Link.

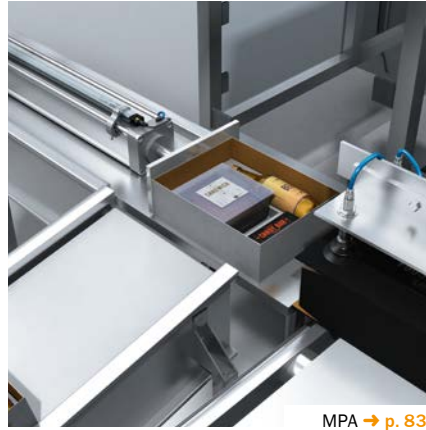

MPA → p. 83



② The right product in the right packaging

Food safety is becoming more and more important. As part of this, it must be ensured that the right product ends up in the right packaging. The Inline Code Matcher quality control system takes care of this by comparing various 1D and 2D codes (code matching) on the packaging. The system offers intuitive operation via an HMI with touch display and can be easily retrofitted.



Inline Code Matcher → p. 124

③ Level measurement on the adhesive container

The tabs on the carton are glued as part of the process. Sufficient adhesive must always be available if smooth operation is to be ensured. The CQ capacitive proximity sensor is suitable for monitoring the level of the adhesive container, since it can measure levels without contact, even through walls.



CQ → p. 83

④ Format adjustments on the side loader

The side loader must automatically convert its stops with a high degree of accuracy for format changeovers so it can guide the new products precisely. The EKM36 motor feedback system with a digital HIPERFACE DSL® interface determines the actual position at a resolution of up to 20 bits per revolution and thus positions the stops with extreme accuracy. Thanks to the integration of the encoder communication in the motor line, HIPERFACE DSL® reduces cabling needs by 50%.



EKS/EKM36 → p. 104

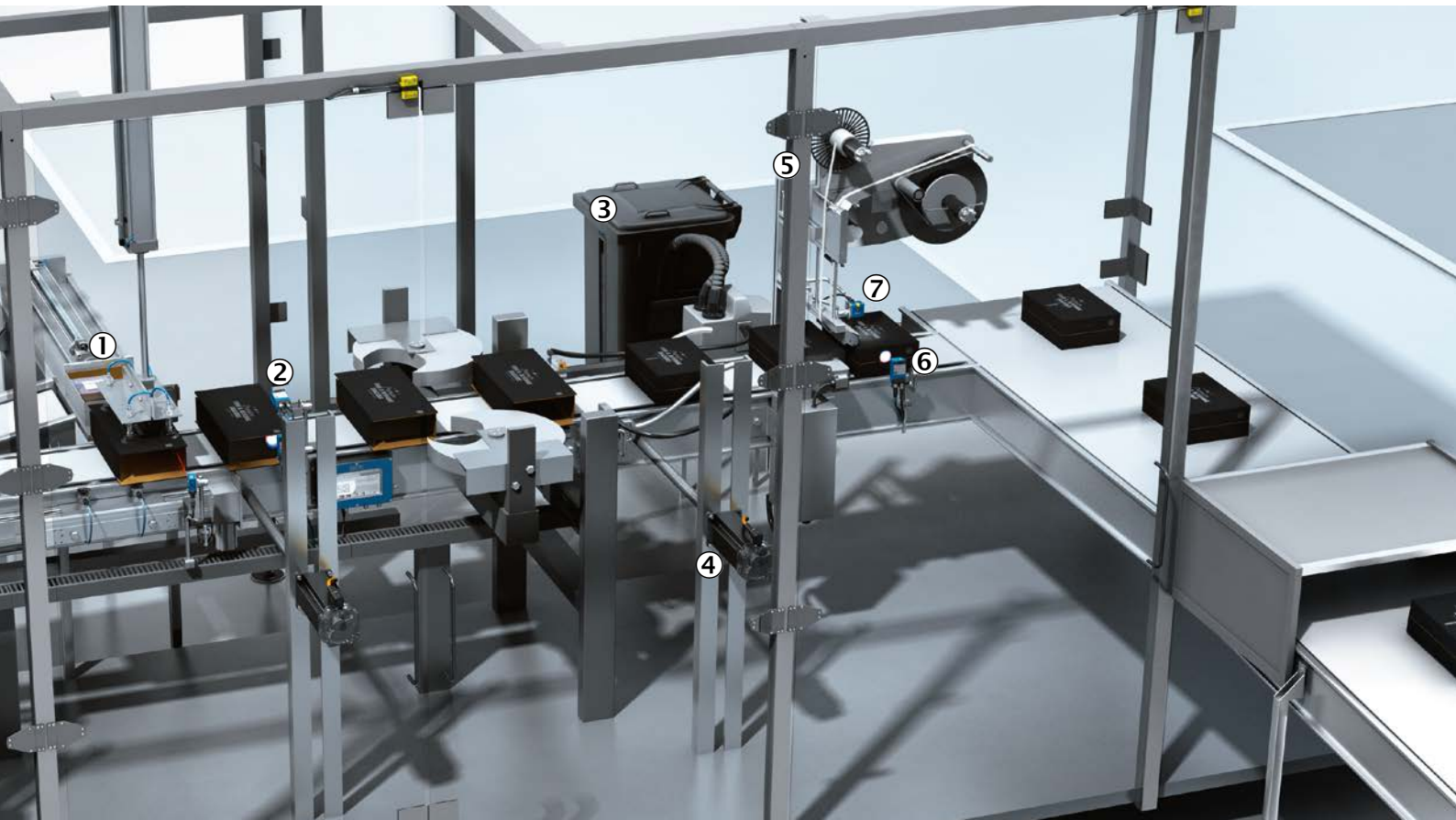

⑤ Quick and reliable label detection

Self-adhesive labels are applied to a variety of differently shaped packaging. The process of dispensing labels is synchronized so that labels are applied in the correct position. The WFS fork sensor detects the label position and can be mounted near the dispenser edge. The sensor does not have to continually search for the gap in the label, as the position is taught in when the sheet is running. Thanks to IO-Link, the switching threshold can be adapted while the process is running.

⑥ Check of best-before date

Once cleartext has been printed, a check must be performed to ensure that the best-before date has been printed correctly and legibly. The Lector620 OCR image-based code reader is the intelligent solution here. It checks the variable data and codes on the packaging systematically for quality and accuracy.

⑦ Checking of seal

In order to close packages safely after filling, many manufacturers use a seal. The Glare sensor detects the presence of the seal due to the different levels of glare on the seal and the packaging. The glare sensor distinguishes with maximum reliability between the clear reflection from the plastic surface of the seal and the diffuse reflections from the rougher surface of the packaging material. Sensor settings, monitoring, advanced diagnostics, and visualization are all achieved via IO-Link.



WFS → p. 85



Lector62x → p. 104

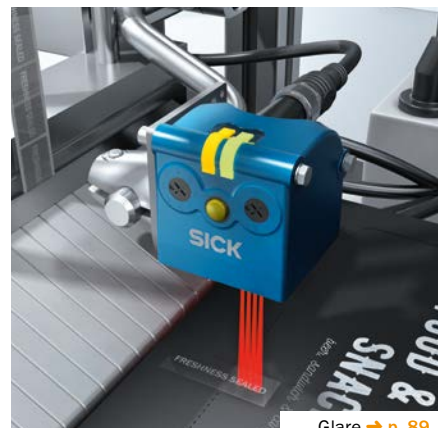

Glare → p. 89

① Safe sensor cascade with convenient diagnostics

The range of safety switches and sensors on a packaging machine requires a wiring diagram to support diagnosis of the connected components. Thanks to the Flexi Loop, up to eight sensor cascades, each with up to 32 dual-channel safety switches and sensors, can be connected and diagnosed in a cost-effective way. Locking devices, signal lamps, and emergency stop pushbuttons can also be connected via standard inputs and outputs.



Flexi Loop → p. 97



② Edge guiding of the packaging film

The film on the packaging machine must be guided so the unwinding process runs correctly. To this end, the edges of the film sheet are taught in with the help of the MLG-2 measuring automation light grid and the position information is used to control the film via two digital outputs. The MLG-2 also detects contamination, color changes, or tears in the film and thus offers inline quality control and sheet width measurement as an additional benefit.



MLG-2 Pro → p. 90

③ Flexible print mark detection for identification of the cutting position

Wrapping machines use rolled-up packaging materials, with the cutting position indicated by a print mark on the film. Reliable detection of the print marks is necessary to prevent defective products and increase productivity. Even at very high speeds, KTS contrast sensors detect minute grayscale variations between the mark and the background on matte, shiny, or transparent surfaces. SICK offers a large selection of variants with different methods of contrast resolution and different teach-in methods.



KTS Prime → p. 87

④ Efficient hazardous point protection

The deTec4 Core safety light curtain protects the film area on an overwrapping machine while the machine is running. The reliable sensor takes up little installation space and does not have any blind zones. The integrated orientation display positions the sender and receiver quickly and reliably. When used in combination with the Flexi Soft safety controller, SICK here offers a complete machine safety solution.



deTec4 Core → p. 93
Flexi Soft → p. 98

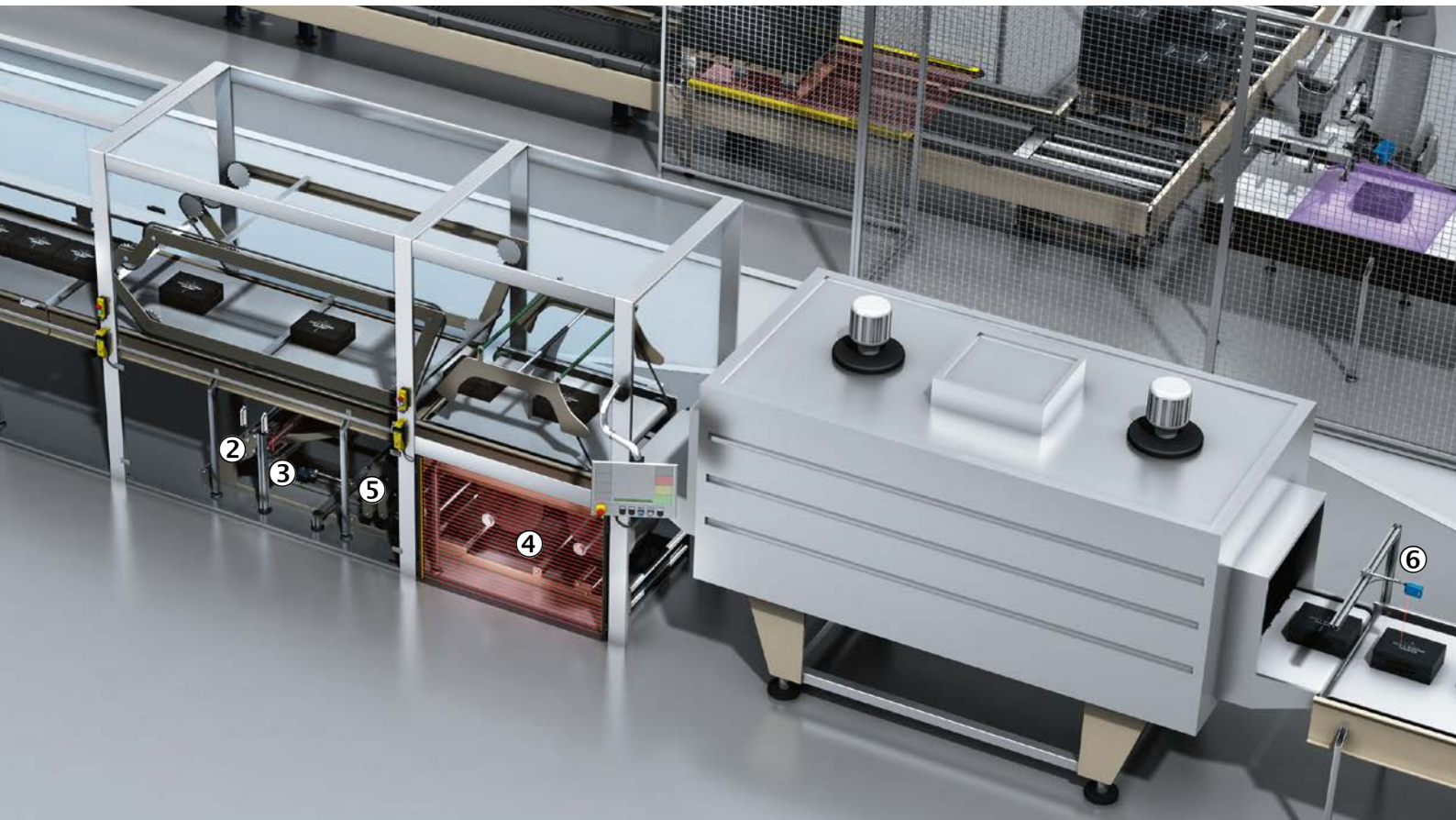

⑤ Monitoring of dancer position for the film tension

A dancer is used to ensure the sheet tension of the packaging film is even. If two-point control is sufficient to monitor the dancer position, IME inductive proximity sensors can be used for this task. They run reliably thanks to their very high shock and vibration resis-

tance, plus they provide a high degree of positioning accuracy in the machine. The most important requirements for inductive sensors are precision, maximum availability, and a long service life, all of which the IME fulfills.

⑥ Detection of cartons and containers

Conveyor belts transport cartons and containers from one machine to the next. Optical sensors monitor transport along this conveying line. The WTS26 photoelectric proximity sensor with Twin-Eye technology® offers the highest level of operational safety when detecting shiny, reflective, or uneven surfaces. This technology achieves a previously unheard of degree of detection stability and ambient light immunity.



IME → p. 82

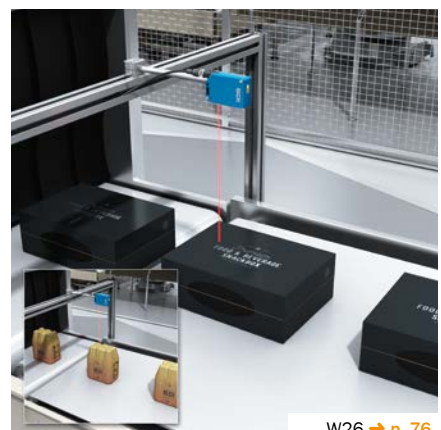

W26 → p. 76

ng: secondary and end-of-line

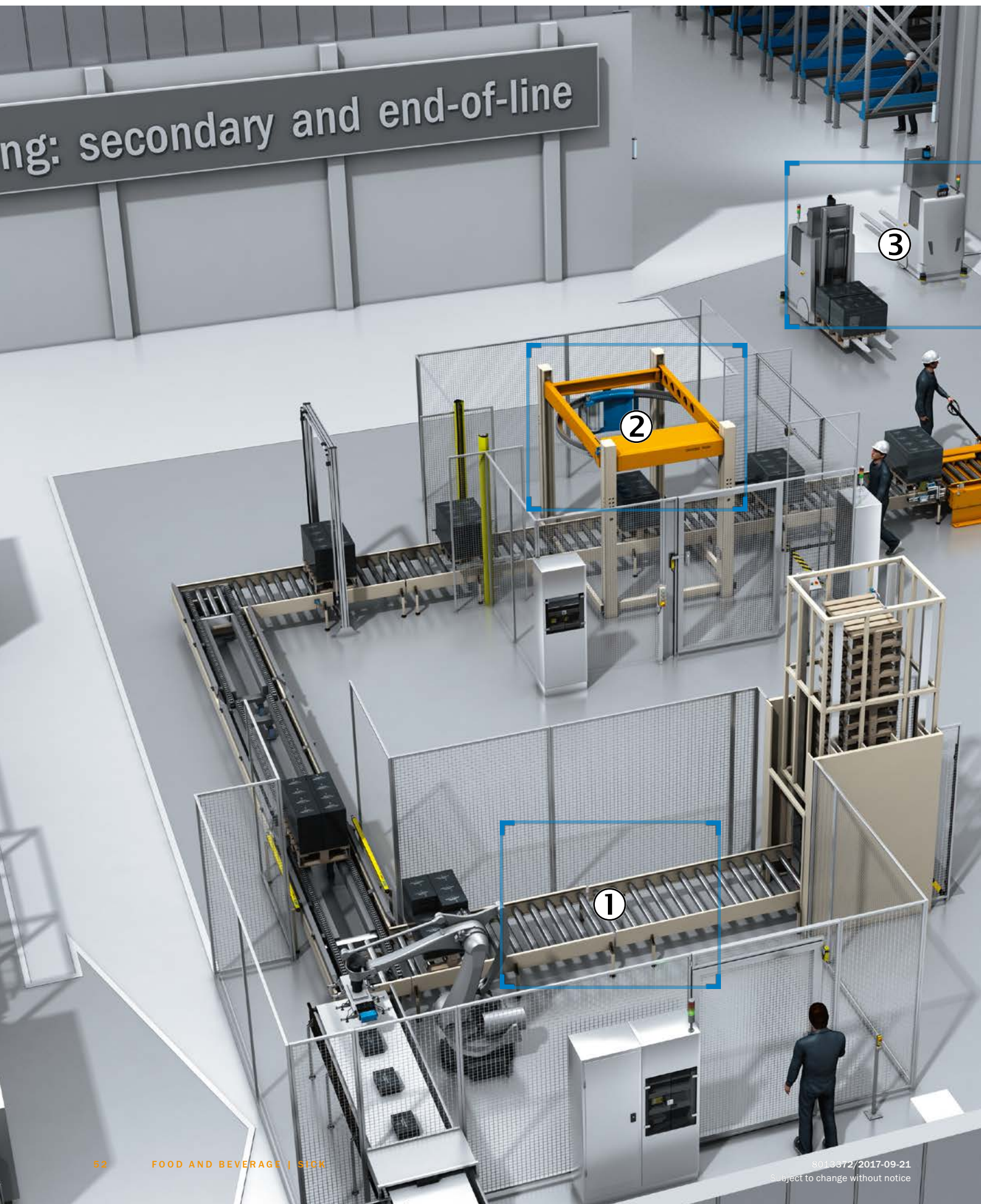



End of line packaging

Focus 1	54
① Pallet handling machine	
Focus 2	56
② Stretch wrapper	
Focus 3	58
③ Automated guided vehicle (AGV)	

① Access protection with automated pallet detection

The pallet handling machine has a material and pallet infeed, plus a pallet outfeed. To protect access to these areas, a C4000 Palletizer safety light curtain is mounted horizontally at the outfeed, where it reliably differentiates between pallets and people. This is an innovative and cost-effective solution that saves on muting sensors, signal lamps, or fence elements, for example.



② Contour measurement for pallet loading

The robot's suction gripper collects several cartons and stacks them on the pallet. The Visionary-T 3D streaming camera determines the position and dimensions of the carton so the robot can correct the predefined positioning data to achieve the right gripping result. The camera is quick to install, ready for operation immediately, and provides reliable, high-quality 3D data in just one shot.



③ Automated pallet handling

Modern robots stack packages on pallets accurately. Servo motors with the EKM36 compact motor feedback system move the robots dynamically and precisely. EKM36 is certified for safe movements up to SIL2 and PL d. The HIPERFACE® DSL interface and One Cable Technology halve the amount of cabling required.



④ Safe speed monitoring

The palletizing robot represents a source of danger during setup or when pallet loading errors need to be rectified. The Drive Monitor FX3-MOC monitors the "safe speed" of the palletizing robot and also provides other drive safety functions, such as "safe stop" and "safe operating stop."



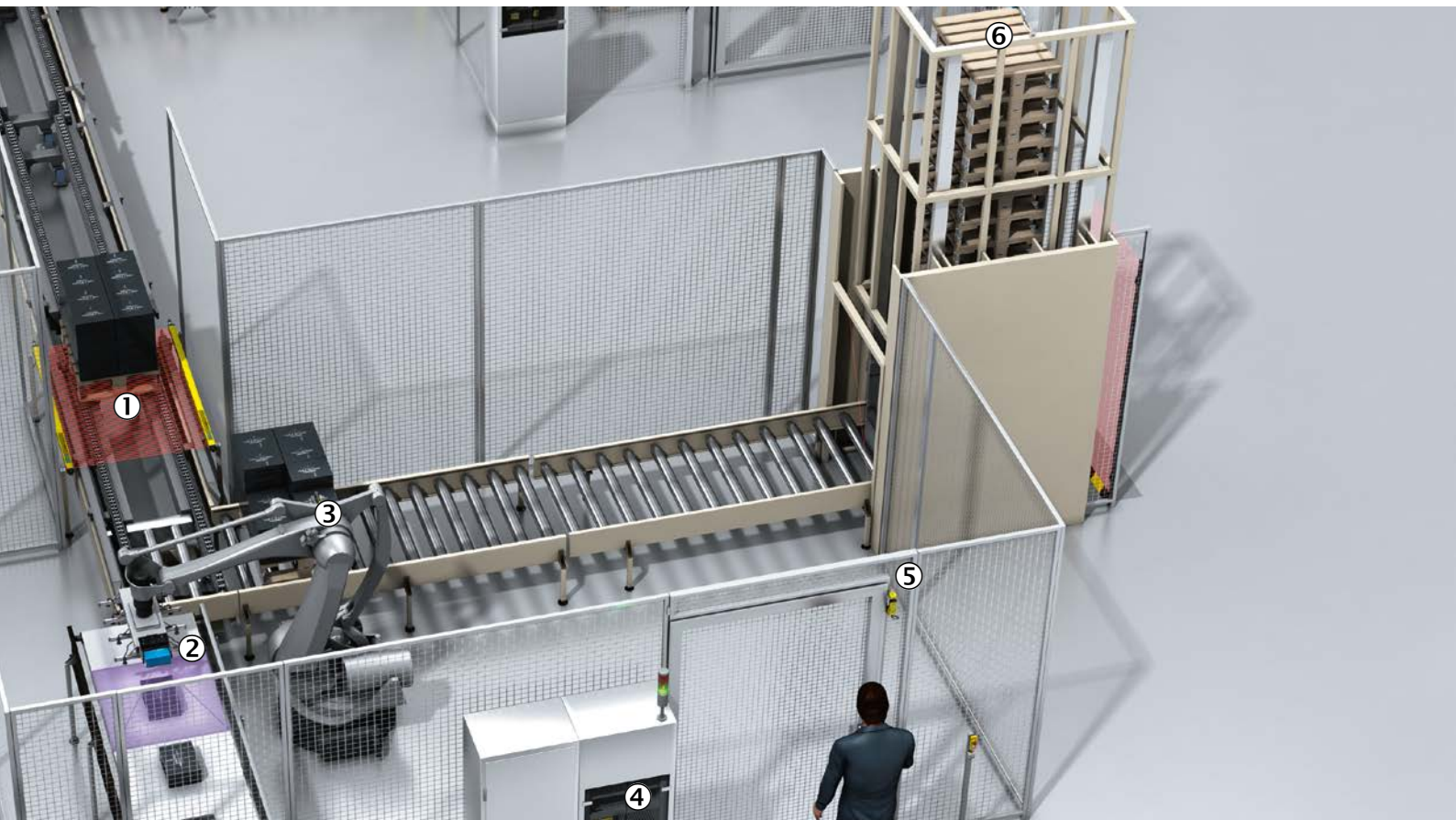

⑤ Safety locking function of the service door

To enable work to be carried out on the pallet handling machine, a service door provides access to the palletizing area. The TR10 Lock safety locking device makes sure that this service door cannot be opened during operation. TR10 Lock combines a high retaining force with the other benefits of transponder-based safety switches, such as coded actuators and self-monitoring semiconductor outputs.

⑥ Monitoring of the stack height

For the pallet handling machine to be operated continuously, the number of pallets in the pallet staker has to be monitored. The PowerProx MultiTask photoelectric sensor detects objects reliably – even with shiny or jet-black surfaces and background reflections. It uses several switching points to monitor the stack height and transmits the data to the control via IO-Link.



TR10 Lock → p. 96

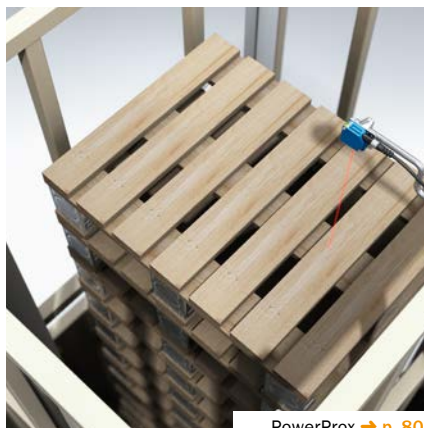

PowerProx → p. 80

① Protrusion monitoring at pallets

Before the pallet enters the stretch wrapper, its dimensions are measured. The load is checked for overruns in order to ensure a smooth wrapping process. The framework arrangement of the programmable MLG-2 Pro automation light grid reduces shadows. A simple alternative is the TiM5xx 2D LiDAR sensor. The volume can also be determined using the VML track and trace system.



VML → p. 126
MLG-2 Pro → p. 90
TiM5xx → p. 116

② Access protection with muting

Loaded pallets are transported via the infeed and outfeed of a stretch wrapper. Workers must be protected against dangerous movements in these areas. The M4000 Advanced multiple light beam safety device is ideal for this task. Combined with the UE403 switching amplifier and the WL27-3 muting sensor, it creates an efficient solution for muting in automated material transport.



M4000 Advanced → p. 94
W27-3 → p. 76

③ Speed monitoring of winding head

In order to optimally control the wrapping process, it is necessary to monitor the speed of the winding head and the number of windings. The high-resolution AFM60 absolute encoder is used here. With the EtherNet/IP™ fieldbus interface, the encoder can be integrated into the machine controller easily and cost-effectively.



AFS/AFM60 EtherNet/IP → p. 101

④ End position monitoring of the winding unit

To achieve a correct wrapping process, the end positions of the upward and downward movements of the winding unit have to be monitored. The reliable IQ40 inductive proximity sensor detects the end positions accurately thanks to its large sensing ranges.



IQ40 → p. 82

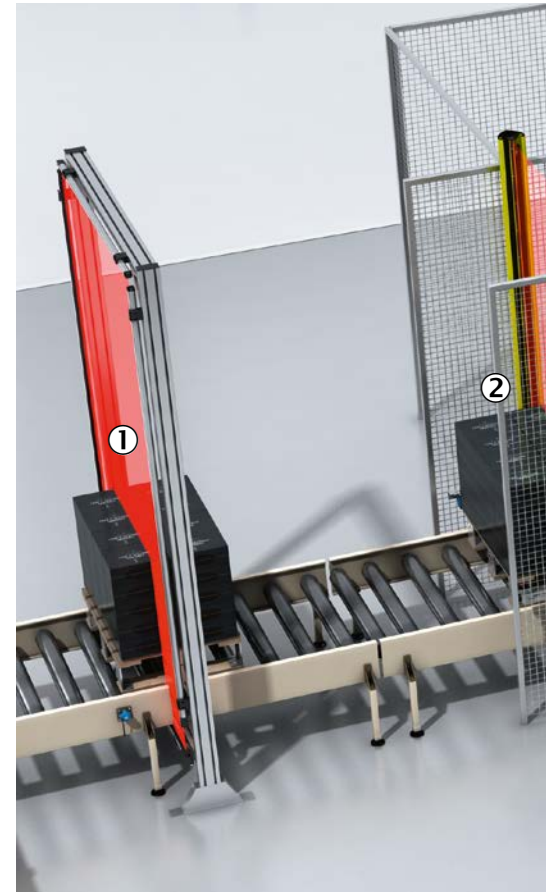

⑤ Presence monitoring of pallets

Before the pallet can be wrapped, it must be perfectly detected and positioned. The SureSense cylindrical photoelectric sensor is suitable for this task and can be aligned quickly and easily during installation based on a continuous signal strength light bar.



SureSense → p. 77



⑥ Safe material lock for standard palletizing tasks

Loaded pallets are wrapped in film automatically. Even in a confined space, personnel still need safe access to the hazardous area of the machine in order to perform maintenance. A vertically mounted S300 safety laser scanner provides access protection. Muting sensors distinguish between whether it

is a person or material that is approaching the lock. Therefore, pallets pass the protective field unimpeded, while if a person enters that area, the machine stops safely. Flexible protective field switching can be realized in the safety laser scanner or together with a Flexi Soft safety controller.

⑦ Identification of loaded pallets

RFID tags are affixed to pallets for identifying the packaging on them. The RFID tags contain all the necessary data. The RFU63x RFID reads and writes the tag data. Support from all established data interfaces and fieldbuses makes it easy to exchange data with the control center or an ERP system.



Flexi Soft → p. 98
 S300 Advanced → p. 92
 S300 Mini Remote → p. 91



RFU63x → p. 106

① Collision avoidance on an AGV

A mobile 3D vision mounted on the vehicle uses its three-dimensional sensing field, which points downward at an angle, to detect the entire area in front of the AGV. This prevents the vehicle from colliding with objects that are hanging down or protruding, or with the fork arms of other vehicles.



Visionary-T → p. 110



② Monitoring of direction of travel and speed for safe movement

The Drive Monitor extension module developed for the Flexi Soft safety controller monitors the direction of travel and speed parameters of the AGV very accurately. Drive Monitor provides the most common interfaces for incremental and absolute encoders. It is particularly efficient when used in combination with safe encoders.



Flexi Soft Drive Monitor → p. 98

③ Protecting AGV

The microScan3 Core safety laser scanner is ideal for protecting AGVs. The warning fields (yellow and orange) that move with the scanner allow for early detection of people in the path of the vehicle, and slow down the vehicle speed. If people reach the protective field (red) on the vehicle, the sensor forces the vehicle to stop.



microScan3 Core → p. 92

④ Safe speed detection on AGV

The DFS60S Pro incremental safety encoder is used on the main drive axle of an AGV to determine a safe speed, while the AFS/AFM60S absolute encoder detects the safe steering angle. The encoders provide data relating to the steering angle and path to the on-board computer or a central computer. The maximum possible speed is then monitored here, depending on the fork lifting height and the steering angle, to ensure the AGV is used effectively. The associated control unit is the Flexi Soft Drive Monitor.



DFS60S Pro → p. 103
Flexi Soft Drive Monitor → p. 98
AFM60S Pro → p. 103

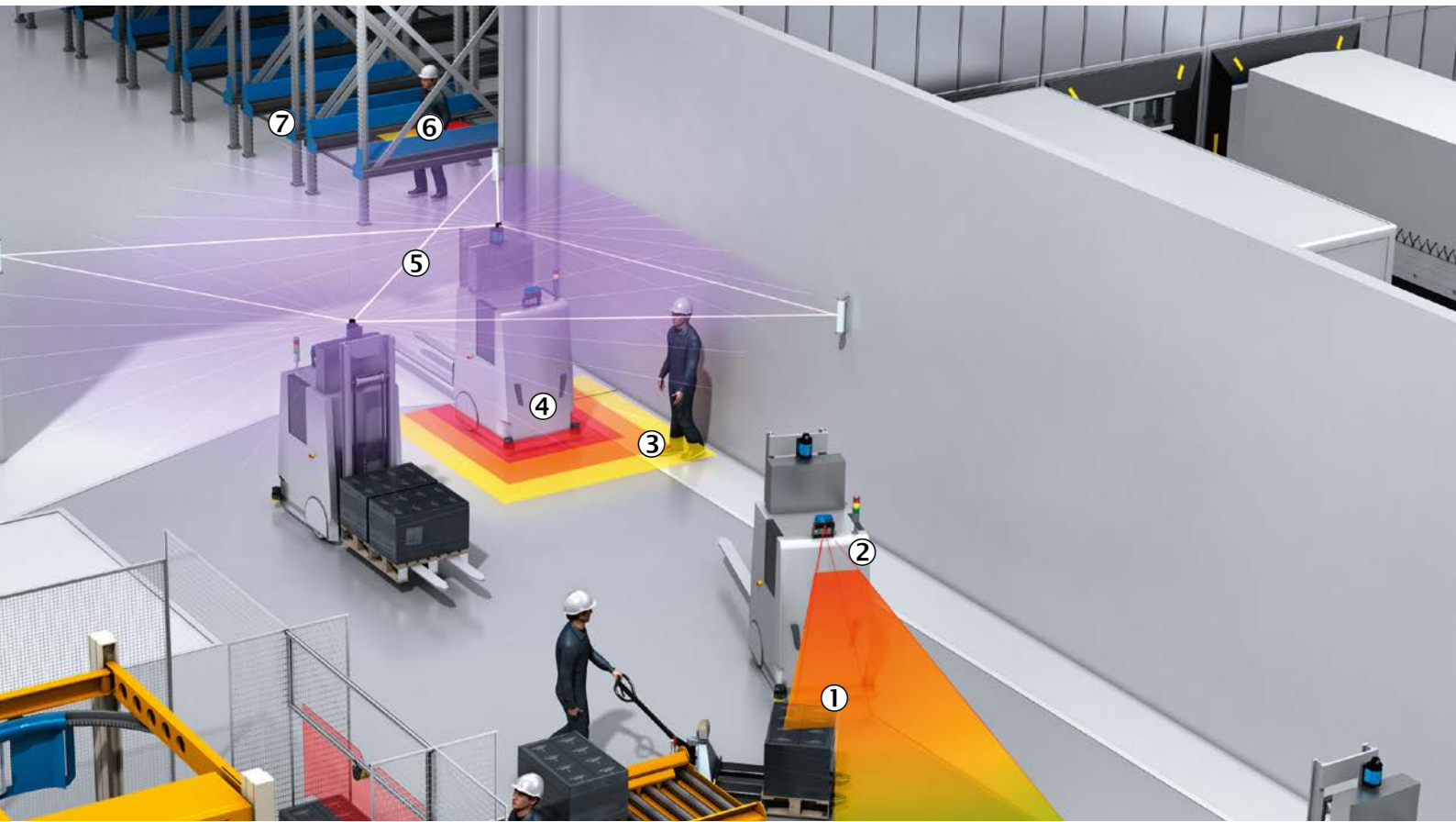

⑤ Navigation in the warehouse with navigation scanners

The NAV3xx 2D LiDAR sensor (also known as a 2D laser scanner) is the first choice for precise and highly dynamic navigation in the warehouse (including in refrigerated areas). The sensor can detect natural and artificial (reflective tape) landmarks and use them to determine the absolute position of the AGV. The sensor works according to the time-of-flight measurement: just three reflectors are sufficient for determining position.

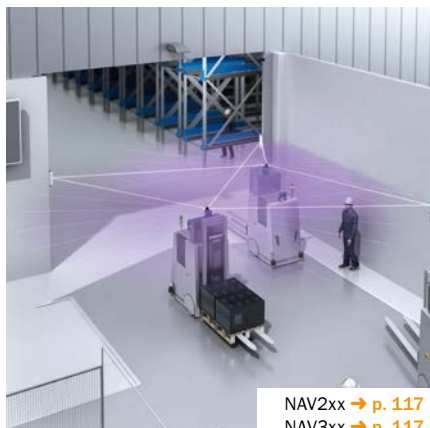

NAV2xx → p. 117
NAV3xx → p. 117

⑥ Protection of operating personnel and collision avoidance at the pallet shuttle

If personnel can access the shuttle path, certain safety functions must be implemented in accordance with applicable standards. Ultra-compact S300 Mini safety laser scanners with switchable protective and warning fields make it possible to implement these safety functions while conforming to standards and to avoid collisions between the shuttles.

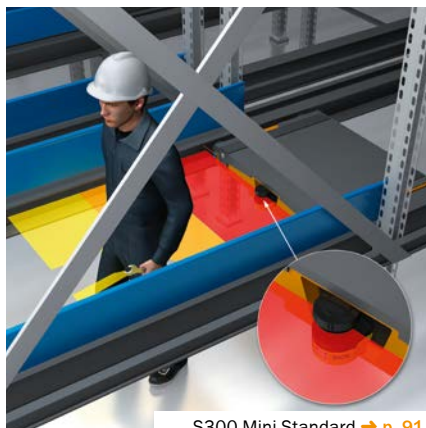

S300 Mini Standard → p. 91

⑦ Detection of the pallet shuttle reference position

At the end of the aisle, the end position of the shuttle is checked against the reflector at the start/stop position, compared with the position value of the encoder on the drive axis, and corrected if necessary. This referencing process allows the positioning accuracy to remain at an equally high level at all times.



G6 → p. 72

FLEXIBLE AUTOMATION

Smart Sensor Solutions – start benefiting from the advantages of intelligent sensors today

Intelligent sensors provide data for Industry 4.0

Integrating sensor and actuator communication at the lowest field level makes the flow of information within an overall automation pyramid completely continuous. Even if the individual sensor functions do differ, the Smart Sensor Solutions implemented in machines always offer significantly greater flexibility, reliability, availability, operability, and efficiency, while optimizing the costs of the individual machine processes at the same time.

Smart Sensor Solutions also provide the technological prerequisites, e.g., via IO-Link, for integration into a machine's control technology and, therefore, its automation network.

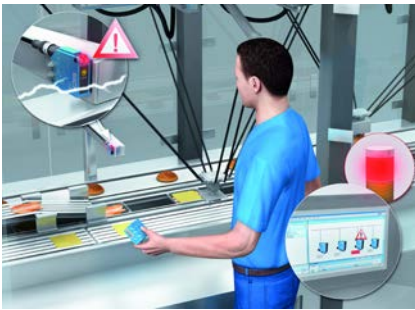

Easy device replacement

- Precise localization of the sensor within the machine and plant
- Sensors can be replaced safely without the need for additional tools or instructions, even if the personnel have not been trained in this area
- Automated configuration prevents incorrect settings



Flexible sensor adjustment

- Parameters for specific formats and configurations can be stored in the sensors or automation system without manual intervention
- Automated configuration prevents incorrect settings
- Reduction in downtimes when product changes take place



High-speed counters

- High-speed counting in the sensor provides an alternative to the central counter module
- Easy and precise speed measuring
- Powerful detection and counting within the sensor instead of the control



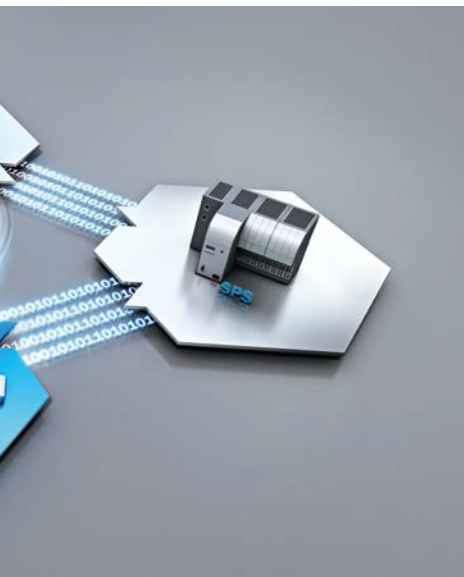

Timers

- Simple and extremely precise time measurement provides the basis for calculating length
- If the belt speed is constant, the length or distance can also be calculated in the sensor
- Linking a sensor to another one makes it possible to determine the speed of the product on the belt without a control

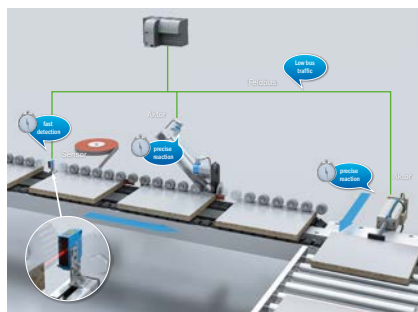

Traceability of products via time stamp

- Every object that enters a sensor's field of view generates a rising or falling edge and time stamps that are set internally
- The PLC receives the sensor time stamp and calculates the actuator time stamp based on this information
- Functional synchronization with sensor/ actuator units

SAFETY

Connect safely, network safely, package safely

“We make business safe” – true to this maxim, SICK has equipped and expanded its modular safety controller with industrial functionalities for packaging plants. Machine manufacturers benefit from the efficient cascading of safety sensors, from the safe networking of modular machines, and, with the Safeguard Detector functional safety system, from the TÜV-certified combination with photoelectric proximity sensors. Safeguard Detector reliably detects the packaging material, thus providing safe contact protection on carton magazines (center photo). Reliable cooperation with robots is another challenge that is no problem at all for SICK and its comprehensive portfolio of safety products. These innovations establish smart and efficient safety concepts for machines and systems in the packaging industry – and SICK is able to offer everything from a single source, from risk analysis to full safety engineering.



Working together with robots

Robots are increasingly taking charge of flexible packaging processes. There are different forms of automation depending on how humans and robots are working together. We need to move from coexistence to cooperation and beyond to full collaboration – where man and machine work together in the same space at the same time. An extensive understanding of robotics applications, expertise in performing risk assessments, and an ideally adapted safety solution are needed here.



Solutions for stretch wrappers

The Safe Stretch Wrapping Solutions functional safety system for stretch wrappers is designed specifically to safeguard machines in compliance with standards. The intelligent concept optimizes productivity and operator acceptance. The infeed and outfeed are protected by safety light curtains with muting, which differentiate between people and materials. Safety locking devices monitor the service doors. The Flexi Soft safety controller provides the safe logic. The solution includes electrical plans, configuration, and validation on site to safeguard comprehensive and efficient safety.





Everything from a single source

SICK Safety Solutions are characterized by safety engineering that is compliant with standards and produces verifiable and documented results. Having retrofitted a huge number of machines and plants around the world, SICK has vital knowledge of how to implement comprehensive complete solutions. You can rely on our years of experience for a reliable and professional result.



Safe networking

The efficacy of the safety-oriented optimization of individual machines is dependent on integrating the safe logic into the packaging line. The Flexi Line functionality upgrade networks up to 32 controls. These can be easily commissioned at the end customer's premises, without any need for programming. If the system is extended or modified, new addressing does not have to be carried out – the topology is confirmed at the touch of a button.



Manipulation-proof switching

SICK provides perfectly coordinated safety controllers and transponder safety switches for applications requiring a high level of manipulation protection. Depending on the coding level, machine manufacturers can dispense with the need for additional measures such as concealed mounting, mounting outside the operator's scanning range, or an additional interlocking device for plausibility checking purposes.

QUALITY CONTROL

Good products need good packaging

In the modern consumer world, attractive packaging is crucial. It advertises and protects the product, as well as providing information about what is inside the packaging itself. Today's mass production methods make consistent quality control especially important. Relying on product control rather than product recalls is designed to prevent hazards for the consumer and to protect a brand's image. Product safety is a customer's right and one that also covers correct and reliable packaging. Legal requirements in terms of hygiene, portioning, and ingredients have to be taken into account here. The quantity, sorting, and number of products must always match. It must be verified that the right container, decoration, and contents information have been used for the right packaging. The huge variety of labels and marks are monitored to ensure they are present, are in the correct position, and show the correct contents. Seals must be checked to ensure they have a tight fit, are in the correct position, and are impermeable too. Modern sensors perform tasks such as monitoring product features, identifying codes, comparing graphics, reading printed images, and many more, thus guaranteeing that packaging is safe for distribution and for the sales period in question.

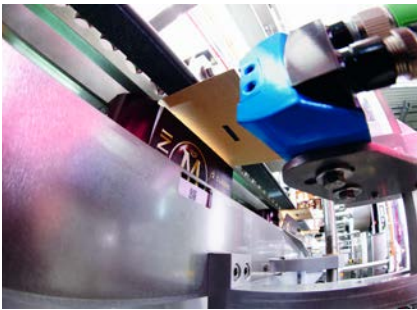

Everything in its place – packaging verification

The Inspector 2D vision sensors are easy to use and provide automation engineers with reliable packaging verification tools. The Inline Code Matcher quality control system (center photo) checks the packaging by evaluating information from several image-based code readers from the Lector® series.

- Detect printed label images to assign the labels to the right packaging
- Check codes on seal and container
- Check that printed best-before date or graphical elements are present
- Read 1D or 2D product codes and compare them with one another



Lid on, bag closed – seal checking

IVC-3D 3D vision cameras use flexible software tools to perform demanding 3D inspections.

- 3D position inspection of lids, pull tabs, or drinking straws
- Checking of vacuum in screw cap jars by measuring the curve of the lid
- Checking of the presence and position of three-dimensional products and packaging parts even for complex shapes





Making sure the bread is tasty – 3D inspection

The Ranger 3D vision can perform very demanding inspection tasks as a high-resolution streaming camera – either in black and white or in color.

- Checking that baked goods have browned correctly
- Checking the volume of pieces of dough and finished products



It is all there – container checking

The TriSpector1000 3D vision sensors offer effective configuration tools for performing 3D inspections easily, quickly, and reliably.

- 3D inspection and detection of presence, number, and shape
- Reliable checking of containers and screw cap jars, based on height information and measured volume values
- High level of color and contrast independence



The dosage makes the poison – accurate dosing

WLL fiber-optic sensors need minimal space and are therefore perfect for taking measurements in difficult installation conditions.

- Accurate optical level measurement
- “Give-away”, i.e., monitoring surpluses, not too little and not too much

TRACK AND TRACE

A safe food chain – only possible with reliable track and trace solutions

Track and trace as well as food safety are all about ensuring transparency with respect to the food's origin and its path through the entire supply chain. Whether it involves processing, filling, or packaging, every process step requires its data to be gathered using a reliable method. This is particularly important for the hygienic requirements which come as standard in the food industry. Sensor solutions from SICK ensure reliable data collection, more transparency by creating traceability, and efficient quality assurance. Our solutions can be integrated seamlessly into existing system networks and feature a high level of connectivity. What's more, sensors from SICK are incredibly rugged. Therefore, they will meet all hygienic requirements even in harsh ambient conditions and will deliver process data reliably.



Traceability of foods

Damage limitation in a product recall

Regulation EC 178/2002 already requires manufacturers within the food industry to establish systems that enable traceability of foods across all stages of production, processing, and distribution. In addition, manufacturers are obliged to recall unsafe products in order to prevent contamination of the food chain. To analyze the causes of a contamination, companies must be able to trace back the trajectory of their products from the producer, through the processing stages, to retailers.



Code reading

When it comes to omni directional code reading, the Lector62x image-based code reader from SICK is highly flexible. Using various image processing algorithms, it reliably identifies all types of codes used in the food industry, such as bar codes (1D), Data Matrix, and QR codes (2D), as well as plain text. It is possible to switch from bar code to 2D and back again without any problems, and with the Lector620 High Speed variant, codes can be read even at speeds of up to six meters per second.





The best choice for optical character recognition

The Lector620 OCR image-based code reader is the ideal solution for reading and comparing plain text in packaging applications. It reads best before dates and batch numbers, e.g., on food and pharmaceutical packaging, and identifies all standard 1D and 2D codes at the same time.



RFID – Powerful technology

RFID is increasingly being used for large pallets or containers of raw material. RFID tags offer a huge advantage over bar codes, primarily because they can be read and written too. What's more, there does not have to be visual contact with the tags and, thanks to their reliability, they are suitable for use in harsh ambient conditions such as where there is moisture, dirt, or high temperatures.

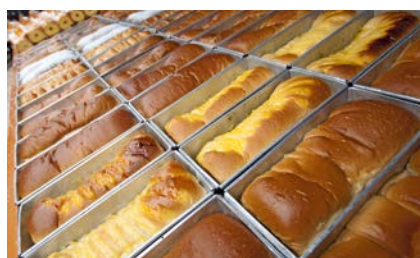
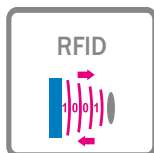

The quality control system from SICK – Asset Monitoring System

The Asset Monitoring System quality control system reads codes in order to collect detailed information regarding the use of equipment or the number of product variants manufactured on a production line. This enables the plant operator to keep track of equipment that is wearing out or the quantity of manufactured product variants at all times. As an easy-to-integrate stand-alone solution, the system is especially suited for retrofitting into existing plants. The modular design with code readers from the Lector6xx product family means the system can be used in all kinds of applications.



HYGIENIC SOLUTIONS

Washdown and hygienic design: an investment that really pays off

One popular method of fulfilling the strict hygiene standards that apply in this context is to clean the systems using high pressure on a daily basis – this means that the individual components are exposed to strong thermal and mechanical loads as well as chemically aggressive cleaning agents, which poses a real challenge to the sensors in place. Machines and systems used to process food are arranged in different zones in accordance with the relevant hygiene requirements.

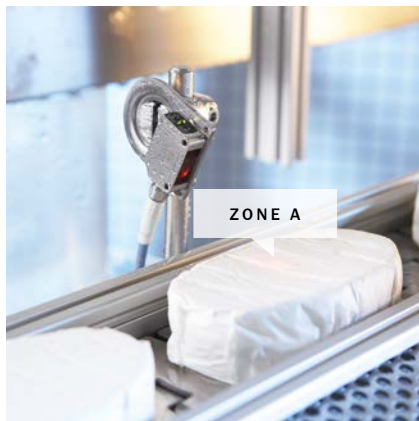

Zone A – Food zone (hygiene zone):

Hygienic sensors are constructed in such a way that they can be used directly in the food zone (hygiene zone) of a machine.

Machines and systems designed hygienically do not provide any scope for buildups of product deposits. Fewer buildups of product deposits mean less cleaning, in turn reducing the amount of detergent, water, and energy required. Plant availability is increased as a result of shorter cleaning processes – this is a real economic benefit, particularly if products are changed frequently.



Zone B – Splash zone (cleaning zone, washdown):

Washdown indicates that the splash zone of a machine can be wet-cleaned easily and quickly – and with this type of cleaning, there will be very few or no residues (food, cleaning agents, or water) left on the surfaces. Sensors in the splash zone must therefore be rugged when exposed to cleaning agents and high-pressure cleaning.



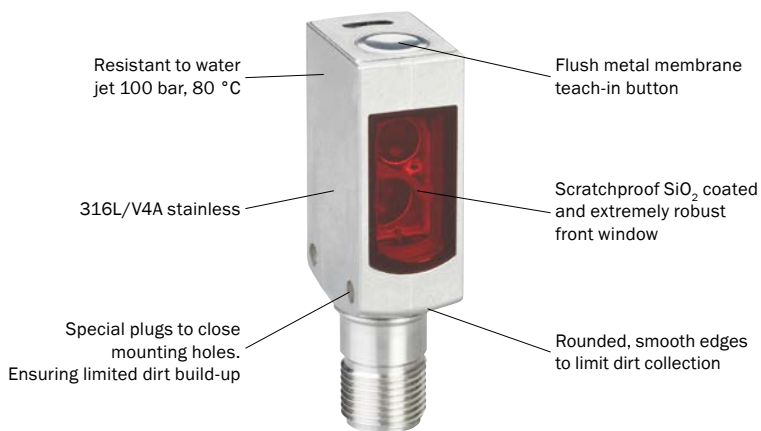

The material makes all the difference

The requirements of sensors are clearly defined:

- Chemical resistance to alkaline, chlorinated, and oxidative cleaning agents and disinfectants
- Thermal resistance, even given dramatic differences in temperature (e.g., cleaning with water at approx. 80 °C in a cold environment at 5 °C)
- Absolute impermeability to liquids



The aim: To manufacture and process food safely

Organizations such as the EHEDG (European Hygienic Engineering & Design Group) or the American 3-A Sanitary Standards, Inc. are developing guidelines, including ones for hygienic machine and system construction.

SICK offers a wide range of solutions which are tested and certified according to international guidelines for worldwide use in the food industry.



No chance of germs, even in the accessories

SICK has developed special mounting systems and connecting cables for use in the food and beverage industry. With Ecolab certification and an enclosure rating of IP69K, resistance to the tested cleaning agents and disinfectants is guaranteed.



PRODUCT OVERVIEW FOOD AND BEVERAGE

Product overview

Miniature photoelectric sensors

W2SG-2	72
G6	72
G6 Inox.	73
W4-3	73
W4-3 Glass	74
W4S-3 Inox	74
W4S-3 Inox Hygiene	75

Small photoelectric sensors

W9-3 Glass	75
W16/W26	76

Compact photoelectric sensors

W27-3	76
-----------------	----

Cylindrical photoelectric sensors

GR18 Inox	77
SureSense.	77

Fiber-optic sensors and fibers

WLL180T	78
WLL170-2	78

MultiTask photoelectric sensors

DeltaPac	79
TranspaTect	79
MultiPac	80
PowerProx	80
Reflex Array	81

Inductive proximity sensors

IMF.	81
IME.	82
IQG.	82

Capacitive proximity sensors

CQ	83
--------------	----

Position sensors

MPA	83
---------------	----

Sensors for T-slot cylinders

MZT7.	84
---------------	----

Color sensors

CSM	84
---------------	----

Fork sensors

UF	85
WFS	85
WF	86

Array sensors

Ax20	86
----------------	----

Contrast sensors

KTS Prime	87
KTM Core	87
KTM Prime.	88
KT5.	88

Pattern sensors

PS30.	89
---------------	----

Glare sensors

Glare	89
-----------------	----

Measuring automation light grids

MLG-2 Prime	90
-----------------------	----

Switching automation light grids

WLG	90
---------------	----

Safety laser scanners

S300 Mini Standard	91
S300 Mini Remote	91
S300 Advanced	92
microScan3 Core	92

Safety light curtains

deTec4 Core	93
C4000 Palletizer	93
deTec4 Core IP69K	94

Multiple light beam safety devices

M4000 Advanced.	94
-------------------------	----

Non-contact safety switches

RE1.	95
STR1.	95

Safety locking devices

TR10 Lock	96
i10 Lock	96

Safety command devices

ES11.	97
---------------	----

Safe sensor cascade

Flexi Loop	97
----------------------	----

Safety controllers

Flexi Soft.	98
---------------------	----

Motion Control safety controllers

Flexi Soft Drive Monitor.	98
-----------------------------------	----

Gas transmitters

TRANSIC100LP	99
------------------------	----

In-situ gas analyzers

GM35	99
GM901.	100

Incremental encoders

DFS60 Inox	100
DFS60	101

Absolute encoders

AFS/AFM60 EtherNet/IP	101
AFS/AFM60 PROFINET	102
AFS/AFM60 EtherCAT®	102

Safety encoders

DFS60S Pro	103
AFx60S Pro	103

Motor feedback systems rotary HIPERFACE DSL®

EKS/EKM36.	104
--------------------	-----

Image-based code readers

Lector62x	104
Lector63x	105

Bar code scanners

CLV64x.	105
-----------------	-----

RFID

RFU62x	106
RFU63x	106

Hand-held scanners

IDM14x.	107
IDM26x	107

2D vision

Inspector.	108
InspectorP63x.	108

3D vision

TriSpector1000	109
IVC-3D	109
Ranger	110
Visionary-T.	110

Sensor Integration Machine

SIM4000	111
-------------------	-----

Displacement measurement sensors

OD Mini	111
OD1000	112
DT20 Hi	112

Mid range distance sensors

Dx35	113
Dx50	113

Ultrasonic sensors

UM30	114
UM18	114
UC4	115
UD18.	115

2D LiDAR sensors

TiM5xx	116
LMS4xx	116
NAV2xx.	117
NAV3xx.	117

Level sensors

LFP Inox	118
LFV200	118
MHF15.	119

Pressure sensors

PBS Hygienic	119
PAC50	120
PHT.	120

Flow sensors

FFU.	121
DOSIC®.	121

Temperature sensors

TBT.	122
TCT.	122
THTS	123
THTE	123

Customized analyzer systems

TRANSIC Extractive	124
------------------------------	-----

Quality control systems

Inline Code Matcher	124
Asset Monitoring System	125

Track and trace systems

VMS410/510	125
VML	126

Functional safety systems

Safeguard Detector.	126
-----------------------------	-----

Accessories

Hygienic design mounting system	127
PVC connection cables	127
Reflectors and optics	128



W2SG-2 – At a glance

- Extremely high sensor size to sensing distance ratio
- High switching point accuracy
- Teach-in functions enable reliable settings
- Automatic switching threshold adaptation
- Single-lens autocollimation for visibility through apertures and drill holes
- Flexible sensor settings, monitoring, advanced diagnostics, and display thanks to IO-Link

Your benefits

- Machine design flexibility: the ultra-compact sensors offer above-average sensing distances and provide space-saving installation
- Remote setup: sensors installed in confined spaces can be set and monitored remotely via IO-Link.
- High operational reliability and system throughput: all familiar, highly-transparent objects are reliably detected
- Precise switching characteristics and a high detection quality guarantee an universal object detecting
- Universal use: conventional mounting and housing design
- The precise light spot of the PinPoint 2.0 LED enables the use of very small reflectors and reflector surfaces

→ www.sick.com/W2SG-2

For more information, simply enter the link or scan the QR code and get direct access to technical data, CAD design models, operating instructions, software, application examples, and much more.



G6 – At a glance

- PinPoint LED for a bright, precise light spot
- Durable metal threaded inserts
- SICK ASIC technology - the result of decades of experience in photoelectric sensors
- Large, user-friendly potentiometer
- Large, bright indicator LEDs
- IP 67 enclosure rating

Your benefits

- Easy alignment and precise object detection due to a highly visible PinPoint LED
- Quick and easy mounting and high durability due to threaded metal inserts
- SICK ASIC technology provides high performance and excellent reliability
- Easy to adjust due to large, user-friendly potentiometers
- Easy to monitor due to large, bright indicator LEDs
- Easy installation with SICK accessories

→ www.sick.com/G6

For more information, simply enter the link or scan the QR code and get direct access to technical data, CAD design models, operating instructions, software, application examples, and much more.





G6 Inox – At a glance

- 1.4404/316L stainless-steel housing – high mechanical ruggedness
- High resistance to chemicals – Ecolab-certified
- Scratch-resistant rugged front screen
- IP67-, IP68-, IP69K-tested
- Available as a complete product family Energetic photoelectric proximity sensor with background suppression, photoelectric retro-reflective sensor and through-beam light barrier
- M3 threaded mounting hole
- M8 male connector and 2 m cable variants

Your benefits

- High level of plant availability even when using aggressive cleaning agents or cooling lubricants is guaranteed by the IP 69K enclosure rating and the mechanically stable stainless-steel housing
- Quick and easy mounting due to universally compatible M3 thread
- Minimal size requirements due to compact housing design
- Easy alignment of the sensor from sharply defined and highly visible light spot
- Ecolab certifies the use of the G6V Inox in particular in the field of food processing and in areas in which chemical cleaning is necessary
- Simple electrical integration due to complementary outputs on the sensor

→ www.sick.com/G6_Inox

For more information, simply enter the link or scan the QR code and get direct access to technical data, CAD design models, operating instructions, software, application examples, and much more.



W4-3 – At a glance

- Best background suppression sensor in its class
- Universal use of PinPoint technology in all variants
- BGS proximity sensor with laser-like light spot for precise detection tasks
- Reliable setting via 5-turn potentiometer, teach-in button, teach-in via cable or IO-Link
- Flexible sensor settings, monitoring, advanced diagnostics, and visualization thanks to IO-Link

Your benefits

- Low-cost integration due to optimal machine integration in areas with limited space
- Application versatility due to reliable detection of shiny or jet-black objects
- Rugged mounting system with M3 threaded metal inserts reduces maintenance costs due to a long service life
- High immunity to ambient light reduces downtime caused by false trips
- Clearly visible light spot simplifies alignment
- IO-Link provides easy data access from the PLC
- Quick and easy configuration
- Quick and easy integration using function blocks

→ www.sick.com/W4-3

For more information, simply enter the link or scan the QR code and get direct access to technical data, CAD design models, operating instructions, software, application examples, and much more.





W4-3 Glass – At a glance

- Fast and reliable setup via teach-in pushbutton
- Continuous threshold adjustment technology to detect objects in changing conditions such as temperature, contamination and reflector wear
- Versions without polarizing filters to better detect depolarizing objects such as PET bottles, CD sleeves and shrink-wrapped, glossy objects

Your benefits

- Reliable and quick setting via the push of a button
- Flat housing design eliminates alignment or mounting brackets, which saves time and money
- Low-cost machine integration due to small dimensions that enable mounting in areas with space restrictions
- Quick and easy setup due to highly visible intensive light spot
- The PinPoint LED's well-defined, intense light spot simplifies alignment
- Nearly all transparent objects can be reliably detected

→ www.sick.com/W4-3_Glass

For more information, simply enter the link or scan the QR code and get direct access to technical data, CAD design models, operating instructions, software, application examples, and much more.



W4S-3 Inox – At a glance

- WashDown rated for fluid tightness (IP 66, IP 67, IP 68 and IP 69K) and Ecolab certified
- Tough stainless steel housing (316L/1.4404)
- Resistant to a variety of common cleaning and disinfection agents
- Highly visible laser-like light spot due to PinPoint LED
- Teach-in via stainless steel pushbutton with a metal membrane
- Flexible sensor settings, monitoring, advanced diagnostics, and visualization thanks to IO-Link

Your benefits

- Long service life in harsh conditions ensures less downtime and fewer replacement costs
- Quick and easy alignment due to highly visible PinPoint emitter LED
- Easy adjustment via a stainless steel metal membrane teach-in pushbutton
- IO-Link provides easy data access from the PLC
- Quick and easy configuration
- Quick and easy integration using function blocks
- Easy device replacement and identification

→ www.sick.com/W4S-3_Inox

For more information, simply enter the link or scan the QR code and get direct access to technical data, CAD design models, operating instructions, software, application examples, and much more.





W4S-3 Inox Hygiene – At a glance

- Smooth stainless steel housing (316L/1.4404)
- Hygienic mounting using M12-adapter thread or D12-adapter shaft
- IP 66, IP 67, IP 68 and IP 69K enclosure rating and Ecolab certified
- Resistant to a variety of common cleaning and disinfection agents
- Highly visible laser-like light spot due to PinPoint LED
- Teach-in via stainless steel pushbutton with a metal membrane
- Flexible sensor settings, monitoring, advanced diagnostics, and visualization thanks to IO-Link

Your benefits

- Smooth hygienic housing and accessories with no grooves or crevices eliminates the potential for bacteria to grow, providing a more hygienic solution.
- Long service life in harsh conditions ensures less downtime and fewer replacement costs
- Easy adjustment via a stainless steel metal membrane teach-in pushbutton
- Quick and easy alignment due to highly visible PinPoint emitter LED
- IO-Link provides easy data access from the PLC
- Quick and easy configuration
- Quick and easy integration using function blocks

→ www.sick.com/W4S-3_Inox_Hygiene

For more information, simply enter the link or scan the QR code and get direct access to technical data, CAD design models, operating instructions, software, application examples, and much more.



W9-3 Glass – At a glance

- High-performance sensor in ultra-rugged VISTAL™ housing
- Best-in-class optical performance for transparent object detection
- Continuous threshold adaption
- PinPoint LED for highly visible and precise light spot
- Variable mounting with M3 or M4 hole pattern
- Wide range of connection options

Your benefits

- Tough VISTAL™ housing provides reliable installation and operation
- Best-in-class optical performance
- Wide variety of connection, mounting and optical possibilities to solve many different applications

→ www.sick.com/W9-3_Glass

For more information, simply enter the link or scan the QR code and get direct access to technical data, CAD design models, operating instructions, software, application examples, and much more.





W16/W26 – At a glance

- Innovative BluePilot operating concept with LED feedback and an IO-Link interface as standard
- Smart Sensor: Efficient Communication, Enhanced Sensing, Diagnostics, Smart Tasks
- TwinEye technology® for maximum operational safety with shiny, reflective, uneven, or jet-black surfaces – whether they are found individually or in combination
- LineSpot technology for detection reliability with structured or perforated surfaces
- ClearSens technology with mode selection for an optimal view of transparent objects, right through to film tear monitoring
- Photoelectric retro-reflective sensors for the reliable detection of depolarizing objects such as containers and pallets wrapped in film
- Immune to any type of ambient light or reflections from the surroundings

Your benefits

- Simple, precise alignment in a matter of seconds thanks to BluePilot, the operating concept with LED feedback
- Reliable detection of all types of packaging
- High levels of plant availability and operational safety, predictive maintenance
- Durable sensors thanks to rugged VISTAL® housing, which is able to withstand mechanical loads such as vibrations and changing temperature influences
- Flexible, quick sensor settings via IO-Link, which can be reliably reproduced
- Smart Tasks: fast, efficient further processing of the detection signal in the sensor itself; reduces costs, relieves strain on the control, and increases productivity

→ www.sick.com/W16 | www.sick.com/W26

For more information, simply enter the link or scan the QR code and get direct access to technical data, CAD design models, operating instructions, software, application examples, and much more.



W27-3 – At a glance

- Intense visible red emitter LED with consistent light spot for PinPoint versions
- Long sensing ranges with IR LED achieve up to 2500 mm
- Precise background suppression for detection of multi-colored objects
- Universal DC or DC/AC supply voltage
- Operating temperature: -40 °C – +60 °C
- Flexible sensor settings, monitoring, advanced diagnostics, and visualization

Your benefits

- Quick and easy commissioning due to a highly visible red PinPoint LED
- PinPoint technology can replace laser photoelectric proximity sensors in some applications. No laser safety regulations and a longer operating life due to PinPoint technology
- Resistant to ambient light, optical reflections, and crosstalk from other photoelectric devices
- Less contamination due to high operating reserves, reducing downtime
- Resistant to vibrations, reducing downtime
- Operation in harsh environments with temperatures as low as -40 °C
- IO-Link provides easy data access from the PLC
- Quick and easy configuration

→ www.sick.com/W27-3

For more information, simply enter the link or scan the QR code and get direct access to technical data, CAD design models, operating instructions, software, application examples, and much more.





GR18 Inox – At a glance

- 1.4404/316L stainless-steel housing – high mechanical ruggedness
- Resistant to acidic and alkaline cleaning and disinfecting agents – Ecolab-certified
- IP67-, IP68-, IP69K-tested - for wash-down applications
- Available as a complete product family Energetic photoelectric proximity sensor with background suppression, photoelectric retro-reflective sensor and through-beam light barrier
- M18 thread mounting
- M12 male connector and 2 m cable variants

Your benefits

- Simple M18 thread design ensures quick and space-saving mounting into machines and plants
- 3 mm flat, chemically-resistant material of the front screen offers a long service life, reducing maintenance time and costs
- Reliable object detection, even in difficult environments, reduces miscount and increases machine throughput
- Ecolab certifies the use of the GR18V Inox in particular in the field of food processing and in areas in which chemical cleaning is necessary
- Innovative stainless steel accessories provide fast and low-cost installation
- Simple electrical integration due to complementary outputs on the sensor

→ www.sick.com/GR18_Inox

For more information, simply enter the link or scan the QR code and get direct access to technical data, CAD design models, operating instructions, software, application examples, and much more.



SureSense – At a glance

- The most flexible and complete portfolio of hybrid sensors
- New and intuitive light strip
- Best background suppression in the sector
- Detection of transparent objects with AutoAdapt technology
- VISTAL housing

Your benefits

- Solve the vast majority of a customer's applications with a single sensor family
- Standardize mounting designs, accessories, set-up procedures and suppliers
- Fast and simple alignment during installation
- Continuous indication of signal strength
- Reliably sense objects of varying colors and materials
- Transparent object detection in tough environments with minimal need for additional cleaning
- Reduce replacement costs and down time due to damages during installation or use

→ www.sick.com/SureSense

For more information, simply enter the link or scan the QR code and get direct access to technical data, CAD design models, operating instructions, software, application examples, and much more.





WLL180T – At a glance

- Selectable response time up to 16 μ s
- Sensing range up to 20 m (through-beam system); up to 1,400 mm (proximity system)
- Bus-compatible with anti-interference
- 2 x 4-digit digital display
- Adjustable hysteresis
- Rotatable display screen
- High-resolution signal processing
- Programmable time delays

Your benefits

- Reliable, rapid process detection, even under the most difficult ambient conditions, such as dust, spray or mist
- Easy commissioning and product changeover due to external teach-in
- Cross-talk is eliminated when utilizing bus configuration option
- Quick, easy setup and adjustment due to an intuitive operating menu
- Flexible parameter adjustment due to high-resolution signal processing. Hysteresis and time delays can be adapted to suit the application, e.g., when detecting tiny or transparent objects
- Easy-to-read display, even under difficult installation conditions

→ www.sick.com/WLL180T

For more information, simply enter the link or scan the QR code and get direct access to technical data, CAD design models, operating instructions, software, application examples, and much more.



WLL170-2 – At a glance

- Rapid response time (50 μ s)
- Switching threshold adjustment via potentiometer, or teach-in via button or cable
- Four different teach-in modes
- Simple installation
- Red or green LED emitter

Your benefits

- Reliable, rapid process detection
- Low installation costs due to short commissioning time
- Flexible teach-in modes allow the sensor to be customized according to the specific application
- Emitted light ideal for color or contrast detection
- Easy programming via simple potentiometer and switch adjustment

→ www.sick.com/WLL170-2

For more information, simply enter the link or scan the QR code and get direct access to technical data, CAD design models, operating instructions, software, application examples, and much more.





DeltaPac – At a glance

- Delta-S technology[®], four PinPoint 2.0 LEDs and two energy scales, combined with SIRIC[®] and distance measurement technology
- Able to detect object contours with radii of up to 20 mm in any direction
- For belt speeds up to 3.0 m/s or production rates of up to 200,000 packages per hour
- Preconfigured sensors or custom setting of four operating modes via IO-Link
- Compact housing (42 mm x 42 mm x 45 mm) with an IP 67 enclosure rating

Your benefits

- Selective process optimization: information about the number of packages in the process enables better production monitoring
- Better space utilization: no mechanical devices are required to isolate packages, reducing the width of packaging systems and saving space
- Better time management: packages run in push-push mode, which prevents collisions and toppling, and reduces machine downtime
- Stable production for reduced energy consumption
- Fast and intuitive commissioning due to pre-configuration
- Maximum flexibility in the types of objects used thanks to the option of custom-setting four operating modes via IO-Link
- Space-saving mounting due to compact housing

→ www.sick.com/DeltaPac

For more information, simply enter the link or scan the QR code and get direct access to technical data, CAD design models, operating instructions, software, application examples, and much more.



TranspaTect – At a glance

- Advanced SICK technology
- Elimination of the reflector as an error source
- Machine parts can be used as a reference surface
- AutoAdapt for continuous threshold adaptation in contaminated conditions
- PinPoint LED with bright and precise light spot
- Easy-to-use teach-in button
- Status LEDs visible from all sides
- Rugged metal housing (PTFE coating available on request)

Your benefits

- Reliable detection of transparent and semitransparent objects without a reflector
- Reliable detection of objects regardless of color or surface qualities
- Freedom of machine design: no mounting system for the installation of a reflector required
- Quick commissioning: there is no need to mount a reflector or precisely adjust the sensor
- High operational safety: if the background becomes contaminated, object detection will continue uninterrupted
- Machine downtime is minimized: the integrated AutoAdapt function extends the time between cleanings
- Heightened productivity: mechanical and chemical ruggedness due to the metal housing

→ www.sick.com/TranspaTect

For more information, simply enter the link or scan the QR code and get direct access to technical data, CAD design models, operating instructions, software, application examples, and much more.





MultiPac – At a glance

- Two redundant receiver arrays from SICK
- The newest SICK chip technology
- Intense, visible red HighPower LED
- Sensing distance up to 500 mm
- Fast and precise commissioning thanks to the highly visible light spot

Your benefits

- Redundant receiver arrays provide reliable detection of shiny, gloss, dark, or irregular shaped objects without signal interruptions
- Products can be detected using a higher angle of incidence. This removes the typical mounting restrictions associated with detecting these products.
- In applications involving plastic wrapped bottles, the MultiPac replaces current solutions which require expensive mechanical height adjustment
- Allows overhead detection of product that is transported on a single conveyor belt but separated into multiple lanes

→ www.sick.com/MultiPac

For more information, simply enter the link or scan the QR code and get direct access to technical data, CAD design models, operating instructions, software, application examples, and much more.



PowerProx – At a glance

- Time-of-flight technology
- Laser class 1, red and infrared light
- Sensing range for object detection: 5 cm to 4 m
- Switching frequencies of up to 1,000 Hz
- Minimum distance between object and background: 6 mm
- VISTAL™ housing
- Up to 3 independently adjustable switching outputs or one analog output
- IO-Link available as an option (distance value, 8 switching points, smart sensor functions)

Your benefits

- Reliable object detection at high sensing ranges and large detection angles, e.g., even with shiny or jet-black surfaces
- Highly visible light spot simplifies alignment of the red-light versions
- Precise, simple adjustment with potentiometer, teach-in button, or display
- Laser class 1 and therefore eye-safe
- High levels of availability and durability. Rugged even when subjected to high mechanical loads thanks to VISTAL™ housing.
- The world's smallest sensor housing ensures great flexibility when designing machines
- IO-Link extends functionality

→ www.sick.com/PowerProx

For more information, simply enter the link or scan the QR code and get direct access to technical data, CAD design models, operating instructions, software, application examples, and much more.



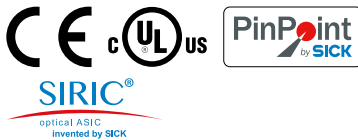

Reflex Array – At a glance

- Detects objects > 12 mm within a 50 mm light array, regardless of position
- Sensing range for detection from 0 m to max. 4.5 m
- Minimum distance of 0.5 m between sensor and reflector for all variants
- PinPoint technology for intense red light
- Automatic adjustment of the switching threshold when there is contamination

Your benefits

- Reduces the installation work required by up to 50% compared to light grids or multiple photoelectric sensors
- Detects objects > 12 mm within a 50 mm light array, regardless of position Three other variants are available for other objects.
- PinPoint technology and optical alignment procedure enables simple and quick commissioning
- Continuous Threshold Adjustment (CTA) ensures less downtime

→ www.sick.com/Reflex_Array

For more information, simply enter the link or scan the QR code and get direct access to technical data, CAD design models, operating instructions, software, application examples, and much more.



IMF – At a glance

- Types: M8 to M30
- Extended sensing ranges: 2 mm to 20 mm
- Electrical configuration: DC 3-/4-wire
- Enclosure rating: IP 68, IP 69K
- Temperature range: -40 °C to +100 °C
- Food-compatible stainless-steel housing, plastic sensing face
- Optical adjustment indicator, IO-Link-ready
- Resistant to industrial cleaning agents, Ecolab-certified

Your benefits

- Reliable processes thanks to extended, highly accurate sensing ranges enabled through the use of SICK ASIC technology
- Reduced machine downtimes thanks to a longer service life, even when subjected to frequent cleaning cycles
- Quick and easy installation thanks to the optical adjustment indicator
- High degree of flexibility and communication options thanks to IO-Link
- Easy to implement customer-specific variants thanks to a modular concept

→ www.sick.com/IMF

For more information, simply enter the link or scan the QR code and get direct access to technical data, CAD design models, operating instructions, software, application examples, and much more.





IME – At a glance

- Types: M8 to M30
- Extended sensing ranges: 1.5 mm to 38 mm
- Electrical configuration: DC 3-/4-wire, DC 2-wire
- Enclosure rating: IP 67
- Temperature range: -25 °C to +75 °C
- Nickel-plated brass housing; plastic sensing face

Your benefits

- High machine availability thanks to rugged design
- Highly cost-efficient thanks to low purchase costs
- Wide selection available thanks to extensive standard portfolio
- High positioning accuracy thanks to precise switching behavior

→ www.sick.com/IME

For more information, simply enter the link or scan the QR code and get direct access to technical data, CAD design models, operating instructions, software, application examples, and much more.



IQG – At a glance

- Type: 40 mm x 40 mm
- Extended sensing ranges: 20 mm to 40 mm
- Electrical configuration: DC 3-/4-wire
- Enclosure rating: IP 68, IP 69K
- Temperature range: -25 °C to +85 °C
- Plastic housing
- Push-lock mounting system
- Sensor head can be rotated in five directions

Your benefits

- Easy to mount in only two seconds without the need for additional tools
- Reliable, cost-effective detection
- The four corner LEDs ensure that the sensor status can be identified from any viewing direction, whatever the mounting position
- Can be easily adapted to numerous applications
- Long sensor service life, even in harsh environments that are subjected to severe weather conditions
- Stable processes thanks to extensive sensing ranges

→ www.sick.com/IQG

For more information, simply enter the link or scan the QR code and get direct access to technical data, CAD design models, operating instructions, software, application examples, and much more.



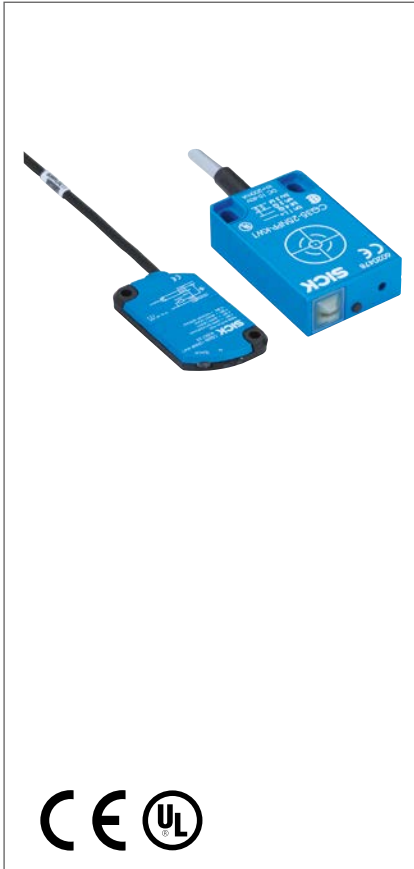

CQ – At a glance

- Rectangular housing
- Detects powders, granulates, liquids, and solids
- Extremely high electromagnetic compatibility
- Electric version: DC, 4-conductor
- Supply voltage: 10 V ... 36 V DC
- Short-circuit protection (pulsed)

Your benefits

- Non-contact level measurement, even through container or tank walls, which eliminates drilling holes and thus reduces installation time
- Durable housing withstands harsh industrial applications, reducing maintenance costs
- Quick and easy adjustment of the switching point - via pushbutton, remote teach for the CQ28 and via potentiometer for CQ35 - saves time
- Simple and safe detection alternative to photoelectric and inductive sensors in applications such as detecting product in a sealed box, container or tank

→ www.sick.com/CQ

For more information, simply enter the link or scan the QR code and get direct access to technical data, CAD design models, operating instructions, software, application examples, and much more.



MPA – At a glance

- Position sensor for use on pneumatic cylinders
- Sensor variants with measuring ranges of 107 mm to 1,007 mm
- Analog outputs (for current or voltage), switching output, and IO-Link
- Mounting with adapters on a multitude of cylinder types (tie-rod cylinders, round body cylinders, profile cylinders)

Your benefits

- Straightforward installation as no position elements or additional mechanical components are required for coupling with the piston rod
- Can be integrated into the machine at any time, as the sensor is attached to the cylinder externally
- Easy adjustment of sensor settings and parameters during operation using a teach pad or IO-Link
- More flexibility compared to conventional cylinder sensors, as it is possible to define multiple switching points in the smallest of spaces
- Maximum reliability thanks to the rugged aluminum housing and non-contact measurement principle
- Advanced diagnostic options thanks to data transmission via IO-Link

→ www.sick.com/MPA

For more information, simply enter the link or scan the QR code and get direct access to technical data, CAD design models, operating instructions, software, application examples, and much more.





MZT7 – At a glance

- Can be used in all standard cylinders, linear slides, and grippers using the T-slot and – with the help of adapters – in round rod, tie-rod, and profile cylinders, and cylinders with a dovetail groove
- Drop-in mounting from above simplifies handling and assembly
- Locking screw combines an Allen key and slotted screw
- LED for indicating the output state
- Enclosure rating: IP 67

Your benefits

- A sensor for a wide range of applications: The sensor design fits into all standard T-slots used around the world, regardless of the cylinder profile or make
- Simple mounting: Thanks to the retaining ribs on the side, the sensor holds its position even before the screw is tightened, ensuring that it does not fall out
- Fast mounting: The sensor is fixed quickly and securely in the slot simply by rotating the fixing screw a quarter turn
- The rugged fixing screw holds the sensor in the required position, even when exposed to shock and vibration
- It is easy to replace the sensor during servicing without removing the end caps

→ www.sick.com/MZT7

For more information, simply enter the link or scan the QR code and get direct access to technical data, CAD design models, operating instructions, software, application examples, and much more.



CSM – At a glance

- Color sensor in a new miniature housing
- Static and teach-in method for 1 color using control cable or control panel
- Over IO-Link up to 8 colors teachable
- Switching frequency: 1.7 kHz
- Sensing distance: 12.5 mm
- Compatibility with older color sensors thanks to cable with male connector M12

Your benefits

- Fast, seamless integration into existing applications thanks to a new miniature housing, saving time and money
- Increased switching frequency for improved machine productivity
- Flexible application possibilities thanks to a wide range of color tolerances
- Enhanced, intelligent diagnostics and visualization, as well as quick and easy format changes, thanks to IO-Link function
- Quick and easy installation cuts down on installation time
- Sorting processes are simplified by the distinction of up to 8 colors in one job

→ www.sick.com/CSM

For more information, simply enter the link or scan the QR code and get direct access to technical data, CAD design models, operating instructions, software, application examples, and much more.





UF – At a glance

- Detection of transparent, opaque or printed labels
- Unaffected by metallic foils and labels
- Fast response time of 250 µs
- Simple and accurate adjustment via teach-in button, or plus/minus buttons
- Rugged, IP 65 aluminum housing

Your benefits

- Great flexibility: UF identifies labels reliably - regardless of whether they are transparent, opaque or printed
- Fast response times enable precise detection – even at high web speeds
- Teach-in function enables quick and easy commissioning
- The aluminum housing meets all requirements for use in harsh industrial conditions
- High process reliability: Ultrasonic technology prevents false detection, which may be caused by ambient light or shiny surfaces

→ www.sick.com/UF

For more information, simply enter the link or scan the QR code and get direct access to technical data, CAD design models, operating instructions, software, application examples, and much more.



WFS – At a glance

- Housing with slim forked shape
- Simple and precise setting of the switching threshold via IO-Link, teach-in button, or plus/minus buttons
- Light/dark switching function
- Fast response time: 50 µs
- PNP or NPN switching output
- Plastic housing with IP 65 enclosure rating
- Smart sensor with integrated IO-Link interface

Your benefits

- Flexible and simple mounting directly on the edge of a label dispenser ensures a high level of accuracy in the process
- Small housing allows simple installation even where space is limited
- User-friendly adjustment allows easy and quick commissioning
- Fast response times enable precise detection – even at very high track speeds
- Thanks to IO-Link or external teach-in, the switching threshold can be adapted while the process is running, increasing process reliability
- Easy to access data from the PLC via IO-Link

→ www.sick.com/WFS

For more information, simply enter the link or scan the QR code and get direct access to technical data, CAD design models, operating instructions, software, application examples, and much more.





WF – At a glance

- Infrared light source
- Simple and precise setting of the switching threshold via IO-Link, teach-in button, or plus/minus buttons
- Fast response time: 100 µs
- PNP and NPN switching output
- Light/dark switching function
- Stable aluminum housing with IP 65 enclosure rating
- Smart sensor with integrated IO-Link interface

Your benefits

- Fast response time and fine resolution ensure reliable detection even at very high object speeds
- Infrared light source provides excellent ambient light immunity
- User-friendly setting via IO-Link, teach-in button, or plus/minus buttons
- A wide range of different fork sizes enables flexible installation
- Stable aluminum housing for use in harsh industrial environments
- Thanks to IO-Link or external teach-in, the switching threshold can be adapted while the process is running, increasing process reliability
- Easy to access data from the PLC via IO-Link

→ www.sick.com/WF

For more information, simply enter the link or scan the QR code and get direct access to technical data, CAD design models, operating instructions, software, application examples, and much more.



Ax20 – At a glance

- Proximity contrast line sensor in a compact housing
- Application-specific sensor functions
- Detect position of edge of material
- Diameter, width and gap detection of different objects
- Very high reproducibility of 0.03 mm
- Large measurement range: 30 mm
- Visible white LED light spot to enable accurate alignment
- Simple setup, no teach-in necessary

Your benefits

- Cost-effective solution to reliably determine edge position and width measurement
- Easy-to-integrate, compact housing can be mounted over the web so less downtime is required for maintenance
- No reflector is required, reducing maintenance and providing greater product reliability. Reduces downtime. Only array sensors available in diffuse mode, making them ideal for environments where dirt and dust can interfere with other types of solutions that require a reflector.
- High reproducibility of 0.03 mm and industry-leading resolution enable greater accuracy and quality control
- Highly visible white LED light spot ensures fast and accurate alignment, reducing time-consuming fine adjustment
- No teach, program or menu activities make setup virtually hassle free

→ www.sick.com/Ax20

For more information, simply enter the link or scan the QR code and get direct access to technical data, CAD design models, operating instructions, software, application examples, and much more.





KTS Prime – At a glance

- TwinEye-Technology for increased depth of field and sensing distance tolerance
- 50 kHz switching frequency and 5 μ s jitter
- Large dynamic range means reliable detection of contrasts on glossy materials
- 7-segment display
- Color mode
- Assembly feedback
- IO-Link and automation functions
- Flexible sensor setting thanks to various sensor parameters

Your benefits

- Small design for installation even where space is limited
- TwinEye-Technology for better performance on glossy or jittering materials - less machine downtime and more process stability
- Multi-functional sensor adjustment for individual sensor adjustment
- Excellent contrast resolution and a large dynamic range for good performance on complex materials
- High flexibility thanks to a range of teach-in processes
- Integrated color mode - stable detection even with complex color differences
- Job storage in sensor - flexible process design and format change
- Diagnostics and visualization as well as easy format change via IO-Link

→ www.sick.com/KTS_Prime

For more information, simply enter the link or scan the QR code and get direct access to technical data, CAD design models, operating instructions, software, application examples, and much more.



KTM Core – At a glance

- Small, tried-and tested housing
- High grayscale resolution
- Very large dynamic range means reliable detection of contrasts on glossy materials
- Switching frequency: 10 kHz
- White light

Your benefits

- Small housing allows installation even where space is limited
- Powerful, fast contrast sensor ensures high machine throughput
- Good contrast resolution and a very large dynamic range ensure good detection performance on glossy materials, thus increasing the range of application possibilities
- Quick and easy configuration

→ www.sick.com/KTM_Core

For more information, simply enter the link or scan the QR code and get direct access to technical data, CAD design models, operating instructions, software, application examples, and much more.





KTM Prime – At a glance

- Small, tried-and-tested housing, also available in stainless steel
- High grayscale resolution
- Very large dynamic range means reliable detection of contrasts on glossy materials
- Static and dynamic teach-in in one variant
- Switching frequency: 15 kHz
- KTM Prime with IO-Link functions

Your benefits

- Small housing allows installation even where space is limited
- Powerful, fast contrast sensor ensures high machine throughput
- Three-color LED technology allows a reliable process, with contrast marks detected even in conditions with weak contrast ratios
- Good contrast resolution and a very large dynamic range ensure good detection performance on glossy materials, thus increasing the range of application possibilities
- Various teach-in methods enable more flexible commissioning
- Long service life, even in harsh environments, thanks to stainless steel housing; as a result, excellent system throughput and low spare parts costs
- Enhanced diagnostics and visualization of sensor parameters, as well as quick and easy format changes, since parameter settings can be downloaded via IO-Link

→ www.sick.com/KTM_Prime

For more information, simply enter the link or scan the QR code and get direct access to technical data, CAD design models, operating instructions, software, application examples, and much more.



KT5 – At a glance

- Best contrast resolution thanks to RGB LED technology
- Intuitive 10-segment bar display indicates the detection reliability
- Dynamic or static teach-in method or manual potentiometer
- Switching frequency of 10 kHz
- Automatic gloss adjustment for highly reflective materials
- Various sensing distances and light spot directions
- M12 plug can be rotated 90°

Your benefits

- Able to process all packaging materials (yellow mark/white background), resulting in high machine throughput
- Reliable operation, even with jittering and high gloss materials
- High positioning accuracy improves packaging quality
- Simple teach-in and highly visible light spot ensure easy setup
- A range of sensing distances, light spot directions and 90° rotatable plug enables optimal integration
- Interchangeable lenses for maximum mounting flexibility

→ www.sick.com/KT5

For more information, simply enter the link or scan the QR code and get direct access to technical data, CAD design models, operating instructions, software, application examples, and much more.





PS30 – At a glance

- Rugged housing with rotatable male connector
- Scanning speed up to 10 m/s
- Reproducibility of up to 0.15 mm (2 Sigma)
- Ethernet interface for integration into the machine controller
- Integrated, visible object illumination
- Operating elements with cleartext display
- Software tools for visualized configuration and diagnosis of the sensor
- Automatic configuration when changing objects

Your benefits

- Reliable detection, including of complex images, reduces system downtimes and rejects
- More freedom with respect to packaging design
- More efficient use of the product surface, as no print marks are necessary
- Faster and easier to change formats by teaching in saved formats
- Reliable production processes thanks to diagnosis of the teach-in and process quality
- Quick and easy sensor alignment thanks to a visible light spot and notches on the housing
- Short set-up times thanks to simple configuration via display, SOPAS web controls, or with PLC/HMI via Ethernet and using the software tools provided

→ www.sick.com/PS30

For more information, simply enter the link or scan the QR code and get direct access to technical data, CAD design models, operating instructions, software, application examples, and much more.



Glare – At a glance

- Object detection and differentiation on the basis of surface gloss level
- Configurable in many different operating modes to meet the requirements of any application
- Integrated alignment aid
- Integrated automation functions
- Two digital push-pull outputs and one configurable input
- Sensitivity adjusts to object properties
- IO-Link provides easy data access from the PLC
- Quick and easy configuration

Your benefits

- Quick installation via alignment mode
- Integrated key lock reduces the risk of operating errors and tampering
- Sensitivity adjustments increase the system's operational safety
- Teach-in via the single teach-in button or SOPAS operating software facilitates quick and easy operation
- Reliable gloss identification regardless of color, labeling or structure increases operational safety
- State-of-the-art detection method makes it possible to conduct inspections at lower costs than with camera solutions
- Sensor's resistance to object fluctuations increases operational safety
- Flexible sensor settings, monitoring, advanced diagnostics, and visualization thanks to IO-Link

→ www.sick.com/Glare

For more information, simply enter the link or scan the QR code and get direct access to technical data, CAD design models, operating instructions, software, application examples, and much more.





MLG-2 Prime – At a glance

- High-resolution light grid: with beam separation of 5 mm, 10 mm, 20 mm, 25 mm, 30 mm und 50 mm
- Available with three push-pull switching outputs or two analog outputs
- Display configuration with selected, pre-programmed measuring functions
- Monitoring height up to 3.2 m
- Operating range up to 8.5 m
- Optical synchronization of sender and receiver
- Cloning function via IO-Link
- Temperature range from -30 °C to +55 °C

Your benefits

- Easy concept: Time and cost savings due to simple configuration and quick commissioning
- Modular concept offers the perfect solution every time from a single source
- Two optical synchronization beams increase operational safety
- Simple maintenance without the need for specialist staff thanks to the cloning function with IO-Link
- Direct configuration on the device display for quick commissioning
- IO-Link as an interface for configuration, measured data transfer and diagnostics
- Minimal specialist knowledge required by the user thanks to the intuitive arrangement of the most essential functions
- Extremely high operational safety due to rugged aluminum housing

→ www.sick.com/MLG-2_Prime

For more information, simply enter the link or scan the QR code and get direct access to technical data, CAD design models, operating instructions, software, application examples, and much more.



WLG – At a glance

- 0.6 ms response time
- Eight visible transmitter LEDs
- Up to eight PNP switching outputs and one alarm output
- Sensitivity can be set via a potentiometer
- Polarizing filter for reflective surfaces

Your benefits

- The fast response time of the WLG means that increased conveyor speeds can be used
- Increased availability thanks to the reliable detection of transparent objects
- Savings in terms of cost and space thanks to the use of a reflector
- A polarizing filter increases process reliability when working with reflective surfaces
- Visible red light reduces mounting time
- Multiple outputs enable the detection of the object position and size for improved system control

→ www.sick.com/WLG

For more information, simply enter the link or scan the QR code and get direct access to technical data, CAD design models, operating instructions, software, application examples, and much more.





S300 Mini Standard – At a glance

- Ultra-compact design
- 1 m, 2 m, or 3 m protective field range
- 270° scanning angle
- 1 field set
- Selectable resolution for hand, leg or body detection
- Contour as reference for vertical applications
- Integrated external device monitoring (EDM)
- Easy-to-configure fields and functions

Your benefits

- Simple integration due to ultracompact design
- Easy installation, commissioning and maintenance for stationary and mobile applications
- Unbeatable cost-effectiveness – 270° scanning angle allows complete application protection with only two scanners
- Safety engineering – with no loss of productivity
- Decades of proven safety technology guarantee maximum reliability and availability – even under difficult conditions
- Easy to manage, reducing costs and work time
- Reduction of downtime and brake wear thanks to triple field function
- Simple alignment and safe operation in vertical mode

→ www.sick.com/S300_Mini_Standard

For more information, simply enter the link or scan the QR code and get direct access to technical data, CAD design models, operating instructions, software, application examples, and much more.



S300 Mini Remote – At a glance

- Can only be used in EFI system network, e.g., with a Flexi Soft safety controller or another safety laser scanner
- Ultra-compact design
- 2 m or 3 m protective field range
- 270° scanning angle
- Up to 16 switchable field sets
- Selectable resolution for hand, leg or body detection
- Extended system solutions in combination with Flexi Soft safety controller

Your benefits

- Simple integration due to ultracompact design
- Easy installation, commissioning and maintenance for stationary and mobile applications
- Unbeatable cost-effectiveness – 270° scanning angle allows complete application protection with only two scanners
- Variety of field sets guarantees safety and productivity when protecting vehicles or moving machine parts
- Easy modular expansions, simple cabling and additional functions using SICK safety controllers with EFI
- Decades of proven safety technology guarantee maximum reliability and availability – even under difficult conditions
- Simple alignment and safe operation in vertical mode

→ www.sick.com/S300_Mini_Remote

For more information, simply enter the link or scan the QR code and get direct access to technical data, CAD design models, operating instructions, software, application examples, and much more.





S300 Advanced – At a glance

- Compact design
- 2 m or 3 m protective field range
- 270° scanning angle
- 4 switchable field sets
- Configuration memory integrated in the system plug
- EFI interface for safe SICK device communication
- Selectable resolution for hand, leg or body detection
- Contour as reference for vertical applications

Your benefits

- Simple integration due to compact design
- Easy installation, commissioning and maintenance for stationary and mobile applications
- Unbeatable cost-effectiveness – 270° scanning angle allows complete application protection with only two scanners
- Safety engineering – with no loss of productivity
- Quick recommissioning via configuration memory
- Easy modular expansions, simple cabling and additional functions using SICK safety controllers with EFI
- Decades of proven safety technology guarantee maximum reliability and availability – even under difficult conditions
- Simple alignment and safe operation in vertical mode

→ www.sick.com/S300_Advanced

For more information, simply enter the link or scan the QR code and get direct access to technical data, CAD design models, operating instructions, software, application examples, and much more.



microScan3 Core – At a glance

- Innovative safeHDDM® scanning technology
- High reliability even when exposed to dust and ambient light
- Up to 8 freely configurable fields
- Up to 4 simultaneous protective fields
- Protective field range 5.5 m; scanning angle 275°
- System plug with configuration memory and M12 plug connectors
- Safe communication via CIP Safety™ in EtherNet/IP™ network

Your benefits

- safeHDDM®: innovative scanning technology for an outstanding ratio between wide scanning range and compact design for simple integration in your machine
- Rugged design: developed for harsh industrial day-to-day work, the microScan3 is resilient and reliable, and increases productivity
- Smart connectivity: low cabling costs due to standardized interfaces, fast device change due to configuration memory, and safe integration into EtherNet/IP™ networks possible
- Intuitive operation: easy commissioning with the Safety Designer software and diagnostic options via the display, pushbuttons, or network

→ www.sick.com/microScan3_Core

For more information, simply enter the link or scan the QR code and get direct access to technical data, CAD design models, operating instructions, software, application examples, and much more.





deTec4 Core – At a glance

- Type 4 (IEC 61496), SIL3 (IEC 61508), PL e (EN ISO 13849)
- Absence of blind zones
- Resolution of 14 mm or 30 mm
- Protective field height of 300 mm to 2.100 mm
- Automatic calibration on the protective field width up to 10 m range
- Ambient operating temperature of -30 °C to +55 °C
- Enclosure rating IP 65 and IP 67
- Flexi Loop-compatible M12 male connector

Your benefits

- Simple assembly with innovative mounting and no blind zones
- Quick commissioning thanks to integrated LED display and automatic measurement of protective field range up to 10 m sensing range
- Simply safe: rugged and reliable thanks to enclosure rating IP67 and an ambient operating temperature down to -30 °C, enabling use in harsh ambient conditions
- Intelligently standardized: M12 connectivity, 5-pin, for cost reductions and a safe series connection with Flexi Loop
- Basic function with minimal configuration effort enables quick replacement when servicing is required

→ www.sick.com/deTec4_Core

For more information, simply enter the link or scan the QR code and get direct access to technical data, CAD design models, operating instructions, software, application examples, and much more.



C4000 Palletizer – At a glance

- Type 4 (IEC 61496), SIL3 (EN 62061), PL e (EN ISO 13849)
- Self-teaching, dynamic blanking for detection of goods and pallets
- Direction detection
- Multiple sampling
- Reduced resolution
- Muting alternative
- Beam coding
- Object gap suppression

Your benefits

- Cost-effective due to the savings made on additional muting sensors or other protective measures
- A compact sensor pair significantly reduces mounting effort – additional muting sensors are not required
- With the dynamic and self-teaching blanking function, the system can reliably differentiate between man and material – this provides maximum safety
- Mixed pallet operation allows mesh boxes, Euro pallets, and half pallets to pass, significantly increasing system throughput
- Saves storage space: pallets can be parked permanently in the protective field
- One system monitors multiple conveyor belts, reducing sensor costs
- Quick commissioning: Detects Euro pallets, mesh boxes etc. without any programming

→ www.sick.com/C4000_Palletizer

For more information, simply enter the link or scan the QR code and get direct access to technical data, CAD design models, operating instructions, software, application examples, and much more.





deTec4 Core IP69K – At a glance

- Type 4 (IEC 61496), SIL3 (IEC 61508), PL e (EN ISO 13849)
- The entire system satisfies enclosure rating IP69K
- Resistance certified in accordance with Ecolab and Diversey
- Easy-to-clean design without edges and gaps
- Protective housing designed to be replaceable
- Breathable membrane prevents protective housing from steaming up

Your benefits

- Enclosure rating IP69K offers high resistance and long service life, making it more economical
- Certified material resistance for maximum reliability
- The ideal design for efficient cleaning in the food industry – it ensures high process and production quality while reducing the risk of contamination
- Replaceable protective housing offers flexibility and saves money in the event that service is needed
- Breathable membrane ensures the highest availability
- Reduction of cleaning times and costs compared to a mechanical protective device

→ www.sick.com/deTec4_Core_IP69K

For more information, simply enter the link or scan the QR code and get direct access to technical data, CAD design models, operating instructions, software, application examples, and much more.



M4000 Advanced – At a glance

- Type 4 (IEC 61496), SIL3 (IEC 61508), PL e (EN ISO 13849)
- Robust housing with three mounting grooves
- Wide scanning range, up to 70 m
- External device monitoring (EDM), restart interlock, application diagnostic output, SDL interface
- Muting in combination with the UE403 muting switching amplifier
- 7-segment display
- Configuration and diagnostics via PC
- Optional integration features: laser alignment aid, LED

Your benefits

- The wide scanning range allows the device to be customized according to the application
- Robust design with a high level of resistance to environmental changes ensures high machine availability, even under special ambient conditions
- Mounting grooves on three housing sides ensure more mounting flexibility and simplify machine integration
- Customer-friendly interfaces and status display simplify commissioning and maintenance
- For 2- and 4-sensor muting, the on-site connection of the muting signals significantly minimizes wiring costs and simplifies commissioning and maintenance
- Reduced downtime due to 360° visible LED, diagnostics displays and configuration memory in the UE403 muting switching amplifier

→ www.sick.com/M4000_Advanced

For more information, simply enter the link or scan the QR code and get direct access to technical data, CAD design models, operating instructions, software, application examples, and much more.





RE1 – At a glance

- Response range up to 7 mm
- 2 or 3 contacts
- Up to performance level PL e (EN ISO 13849)
- Sensors with plug connector or connected cable
- Flexi Loop-compatible M12 plug connector (depending on variant)

Your benefits

- Long service life due to durable and low-maintenance design
- Space-saving mounting due to compact housing design
- Just one safety switch in conjunction with a suitable safety module makes it possible to solve applications up to PL e and Cat. 4 (EN ISO 13849)
- High level of machine availability due to high tolerances for door misalignment
- The devices are easy to clean, making them suitable for contaminated areas or environments with strict hygiene standards
- Flexi Loop now enables a safe series connection with enhanced diagnostics capabilities and minimal wiring effort.

→ www.sick.com/RE1

For more information, simply enter the link or scan the QR code and get direct access to technical data, CAD design models, operating instructions, software, application examples, and much more.

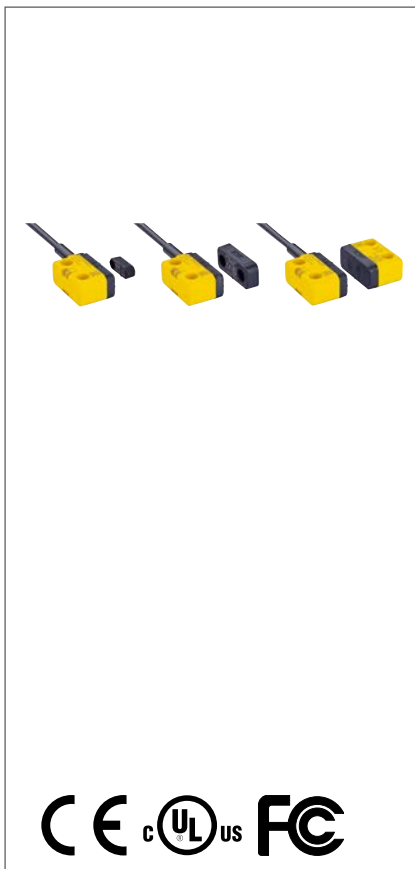

STR1 – At a glance

- Response range of up to 14 mm
- Small housing with flexible mounting options
- Sensor activation possible from three sides
- Three different actuators available
- Universally coded, uniquely coded, and permanently coded sensors
- PL e (EN ISO 13849), SIL3 (IEC 61508)
- Reliable series connection of up to 30 sensors possible

Your benefits

- High level of flexibility when mounting the sensor and actuator
- Reduced need for storage, as one sensor is suitable for a wide range of different applications
- High level of manipulation protection due to individually coded actuator
- High level of machine availability due to large door offset tolerance and high level of shock and vibration resistance
- Economical solution due to series connection of up to 30 sensors
- Fast diagnosis via LED status indicator
- Long product service life due to low-wastage and low-maintenance configuration

→ www.sick.com/STR1

For more information, simply enter the link or scan the QR code and get direct access to technical data, CAD design models, operating instructions, software, application examples, and much more.





TR10 Lock – At a glance

- PL e for door and locking monitoring (EN ISO 13849)
- 1,690 N locking force
- RFID actuator with low or high coding level (EN ISO 14119)
- Enclosure rating IP 67, IP 69K
- Power to lock or power to release variants
- Reliable series connection of safety outputs (OSSDs)
- Four actuation directions
- Flexi-Loop-ready

Your benefits

- The high coding level of the actuator meets all the EN ISO 14119 requirements relating to manipulation-proofing without additional measures
- Self-monitoring semiconductor outputs (OSSDs) afford a high level of safety
- Reliable series connection reduces installation work
- Rugged IP 69K housing ideally suited to use in heavily contaminated environments
- Slim housing design with flexible actuator installation options enables simple machine integration
- Bistable solenoid coil consumes only a small amount of power and produces no heat when the system is either locked or unlocked
- Fast diagnosis via LED status indicator

→ www.sick.com/TR10_Lock

For more information, simply enter the link or scan the QR code and get direct access to technical data, CAD design models, operating instructions, software, application examples, and much more.



i10 Lock – At a glance

- Narrow plastic housing
- Rigid or mobile actuators
- Available with M20 X 1.5 cable entry glands or Flexi Loop-compatible M12 plug connector (depending on variant)
- Locked by spring force and magnetic force
- Lock and door monitoring
- IP 67 enclosure rating

Your benefits

- Small design simplifies installation and makes it easy to mount directly on the guard door frame
- Flexible electrical connectivity due to three cable entry glands
- Improved diagnostics due to additional signaling contacts
- Practical, simple adjustment due to various actuators that are suitable for any door
- Different switching elements offer the appropriate solution for electrical installation
- Flexi Loop now enables a safe series connection with enhanced diagnostics capabilities and minimal wiring effort.

→ www.sick.com/i10_Lock

For more information, simply enter the link or scan the QR code and get direct access to technical data, CAD design models, operating instructions, software, application examples, and much more.



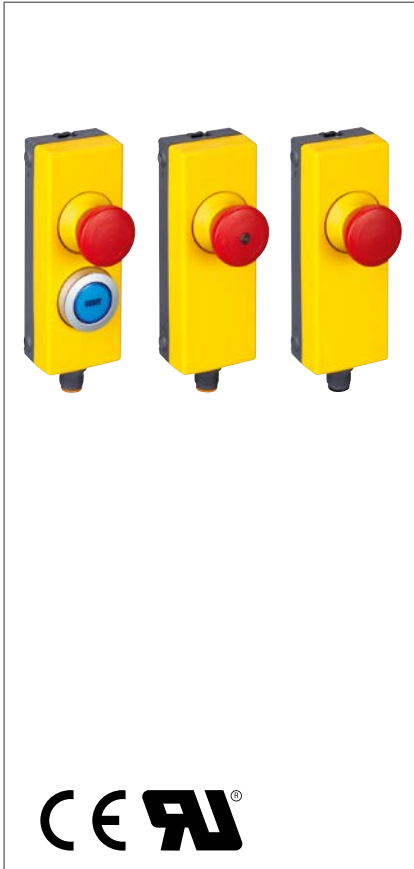

ES11 – At a glance

- Slim plastic housing with quick disconnect mounting clip
- Available as an emergency stop pushbutton or as a combined emergency stop/reset unit
- Emergency stop pushbutton with optional LED illumination
- Illuminated reset pushbutton
- Flexi Loop-compatible M12 plug connector

Your benefits

- Easy mounting with snap-in connection
- Quick commissioning and rapid replacement thanks to M12 plug connector
- User-friendly status display
- With Flexi Loop: safe series connection including diagnostics with easier wiring

→ www.sick.com/ES11

For more information, simply enter the link or scan the QR code and get direct access to technical data, CAD design models, operating instructions, software, application examples, and much more.



Flexi Loop – At a glance

- Ability to cascade 32 sensors with up to 100 m per segment in compliance with performance level e
- Compatible with sensors from all manufacturers
- Detailed diagnostics information
- Integrated standard inputs and outputs
- Voltage supply for sensors is included
- Unshielded standard cable featuring M12 connectivity
- Enclosure rating IP 65 and IP 67
- Intelligent accessories for field diagnostics and commissioning

Your benefits

- Cascading of safety switches and safety sensors with OSSD outputs minimizes the wiring effort and the number of inputs of the safety controller, which saves costs
- Easy retrofitting of existing machines
- Simple calculation of the performance level saves time since the Flexi Loop node monitors each sensor individually
- User-friendly due to quick and easy configuration
- Ability to be used over long distances increases application flexibility
- Detailed diagnostic information minimizes system downtime
- Seamless system integration and communication with other SICK safety controllers
- Detailed status information on Flexi Loop components, diagnostics accessories, and safety controller enable quick and easy field diagnostics

→ www.sick.com/Flexi_Loop

For more information, simply enter the link or scan the QR code and get direct access to technical data, CAD design models, operating instructions, software, application examples, and much more.





Flexi Soft – At a glance

- Expansion modules, Motion Control modules, and gateways for all common fieldbuses
- Configuration data stored in the system plug
- Safe networking of up to 32 Flexi Soft stations
- Integration of sensor cascade
- Multi-language, license-free configuration software: exceptionally simple operation, plausibility check, simulation mode, wiring diagram, parts list, documentation, and data recorder

Your benefits

- Scalable for an efficient and cost-optimized safety application solution
- Cost savings: Flexi Soft offers a modular structure that is in line with your requirements, and thus offers an ideal level of granularity
- Intuitive configuration software featuring comprehensive functions enables continuous monitoring of the configuration
- Rapid verification of the safety application: The configuration software provides documentation and a wiring diagram
- Safety logic is easy to create thanks to ready-made, TÜV-certified function blocks
- The main module's diagnostics interfaces and the configuration storage facility in the system plug enable rapid commissioning, component replacement, and troubleshooting, resulting in minimum downtimes

→ www.sick.com/Flexi_Soft

For more information, simply enter the link or scan the QR code and get direct access to technical data, CAD design models, operating instructions, software, application examples, and much more.



Flexi Soft Drive Monitor – At a glance

- 7 drive safety functions: SS1, SS2, SOS, SSM, SLS, SDI and SBC
- For all common encoder interfaces
- Programmable logic
- Monitoring of up to 10 speed levels and 4 brake ramps
- Possible to monitor multiple axes

Your benefits

- Integration into a Flexi Soft system with a software tool and a project file allows quick project planning and commissioning
- Easy logic development using predefined, modifiable, freely configurable applications
- Maximum level of integration into higher-level controllers via all common fieldbus systems using gateways
- Documentation of the entire safety application simplifies machine acceptance and validation
- Monitoring movements instead of shutting down increases machine productivity
- Flexibility due to a wide range of drive safety functions

→ www.sick.com/Flexi_Soft_Drive_Monitor

For more information, simply enter the link or scan the QR code and get direct access to technical data, CAD design models, operating instructions, software, application examples, and much more.





TRANSIC100LP – At a glance

- O₂ transmitter based on high-performance laser spectroscopy (TDLS)
- For use in use in explosion-hazardous areas (FM, ATEX and IECEx approvals)
- Measurement directly in the process or extractive using a measurement gas cell (option)
- Designed for heavy-duty industrial applications
- Compact design and easy to operate
- Long-term stability
- No moving parts

Your benefits

- Measures in real-time directly in the process
- Easy installation and operation
- Self-diagnostics with maintenance display
- Low requirements for gas conditioning
- Low operating costs: no consumables and no purging gas consumption
- Rugged: reliable measurement even in contaminated gases

→ www.sick.com/TRANSIC100LP

For more information, simply enter the link or scan the QR code and get direct access to technical data, CAD design models, operating instructions, software, application examples, and much more.



GM35 – At a glance

- Dynamic humidity correction
- Fast in-situ measurement directly in the process
- Simultaneous determination of up to three gas components, temperature, and pressure
- No gas sampling and conditioning
- Gas testable version of measuring probe available
- Integrated self-test and control functions

Your benefits

- Dynamic humidity measurement directly in the process
- Provision of real humidity reference values
- Unbiased measuring values due to in-situ measurement
- Fast or short-term fluctuations in the process are being detected
- Representative measurement by selection of an appropriate probe or cross-duct type

→ www.sick.com/GM35

For more information, simply enter the link or scan the QR code and get direct access to technical data, CAD design models, operating instructions, software, application examples, and much more.





GM901 – At a glance

- Representative measurement along the duct diameter
- Operation via evaluation unit
- Short response times
- Verifiable with gas-filled cell; gas-testable probe with test gas

Your benefits

- Measurement results in real time due to in-situ measurement
- Fast and simple installation and commissioning
- Easy, user-friendly operation
- Economical due to low maintenance

→ www.sick.com/GM901

For more information, simply enter the link or scan the QR code and get direct access to technical data, CAD design models, operating instructions, software, application examples, and much more.



DFS60 Inox – At a glance

- Housing, flange, and shaft made from stainless steel
- Face mount flange, servo flange, or square flange with solid shaft and blind hollow shaft
- IP 67 enclosure rating
- Resolution up to 65,536 pulses
- Radial cable outlet or M12 male connector
- Electrical interfaces: TTL/RS-422, HTL/Push Pull, SinCos 1 V_{pp}
- Can be programmed with the PGT-08-S and PGT-10-Pro as an option

Your benefits

- High resistance to environmental influences due to stainless-steel housing
- IP 67 enclosure rating and shaft sealing ring for optimum tightness
- Simple mounting thanks to compact dimensions, even with limited installation space
- The wide range of mechanical interfaces allows an optimal match between the encoder and the application-specific installation situation
- High resolution up to 16 bits enables applications with demanding requirements for measurement accuracy
- Reduces storage costs and downtimes since customers can program the encoder themselves with programming devices PGT-08-S and PGT-10-Pro
- Programmable zero pulse position simplifies installation

→ www.sick.com/DFS60_Inox

For more information, simply enter the link or scan the QR code and get direct access to technical data, CAD design models, operating instructions, software, application examples, and much more.





DFS60 – At a glance

- Compact installation depth
- High resolution up to 16 bits
- Optionally programmable: Output voltage, zero pulse position, zero pulse width and number of pulses
- Connection: Radial or axial cable outlet, M23 or M12 connector, axial or radial
- Electrical interfaces: 5V & 24V TTL/RS-422, 24 V HTL/push pull
- Mechanical interfaces: face mount or servo flange, blind or through hollow shaft
- Remote zero set possible

Your benefits

- Reduced storage costs and downtime due to customer-specific programming
- Variety of different mechanical and electrical interfaces enable the encoder to be optimally adjusted to fit the installation situation
- Excellent concentricity even at high speeds
- High resolution of up to 16 bits ensures precise measurements
- Permanent and safe operation due to a high enclosure rating, temperature resistance and a long bearing lifetime
- Programmability via the PGT-08 programming software and the PGT-10-Pro display programming tool allow the encoder to be adapted flexibly and quickly according to customer needs
- Programmable zero pulse position simplifies installation

→ www.sick.com/DFS60

For more information, simply enter the link or scan the QR code and get direct access to technical data, CAD design models, operating instructions, software, application examples, and much more.



AFS/AFM60 EtherNet/IP – At a glance

- High-resolution, 30-bit absolute encoder
- Integrated web server and FTP server
- DLR (Device Level Ring)
- Function module
- Comprehensive diagnostic functions
- IP addressing via software or hardware
- Round axis functionality (transmission calculation)

Your benefits

- Integrated web server for easy configuration without the need for specialized interface knowledge
- FTP server for firmware updates directly on site and in existing systems
- DLR (Device Level Ring) for enhanced system throughput thanks to redundant network communication
- Status display via five duo LEDs on the sensor for a quick initial indication of the operational status
- Comprehensive diagnosis via the 32-bit fault header
- Round axis functionality for full scalability for binary and non-binary resolutions as well as not complete multiturn revolutions (transmission calculation)
- Individual IP address via DHCP or pre-defined IP address via DEC switches

→ www.sick.com/AFS_AFM60_EtherNet_IP

For more information, simply enter the link or scan the QR code and get direct access to technical data, CAD design models, operating instructions, software, application examples, and much more.





AFS/AFM60 PROFINET – At a glance

- High-resolution 30-bit absolute encoder (18-bit singleturn and 12-bit multiturn)
- Face mount flange, servo flange and blind hollow shaft
- Connection type: 3 x M12 axial male connector
- PROFINET-IO-RT interface
- Less than 5 ms data update time
- Round axis functionality
- Alarms, warnings and diagnostics functions for speed, position, temperature, operating time, etc.
- Status display via 5 LEDs

Your benefits

- Increased productivity as a result of intelligent diagnostics functions and rapid data transfer
- Increase in network reliability due to early error detection
- Simple installation with various configuration options
- Flexible, easy setup and high resolutions for various applications with binary, integer and „decimal point“ values based on round axis functionality
- Maximum system availability through embedded switch technology
- Compact and cost-efficient design

→ www.sick.com/AFS_AFM60_PROFINET

For more information, simply enter the link or scan the QR code and get direct access to technical data, CAD design models, operating instructions, software, application examples, and much more.



AFS/AFM60 EtherCAT® – At a glance

- High-resolution 30-bit absolute encoder (18-bit singleturn and 12-bit multiturn)
- Face mount flange, servo flange and blind hollow shaft
- Connection type: 3 x M12 axial connector
- Data transfer speed „on the fly“ in the range of μ s
- EtherCAT® interface CoE (CiA DS-301) Device profile (CiA DS-406)
- Round axis functionality
- Alarms, warnings and diagnostics functions for speed, position, temperature, operating time, etc.
- Status display via 5 LEDs
- Up to 16 adjustable electronic cam switches

Your benefits

- Increased productivity as a result of intelligent diagnostics functions and rapid data transfer
- Increase in network reliability due to early error detection
- Simple installation with various configuration options
- Flexible, easy setup and high resolutions for various applications with binary, integer and „decimal point“ values based on round axis functionality
- Maximum system availability through embedded switch technology
- Compact and cost-efficient design

→ www.sick.com/AFS_AFM60_EtherCAT

For more information, simply enter the link or scan the QR code and get direct access to technical data, CAD design models, operating instructions, software, application examples, and much more.





DFS60S Pro – At a glance

- Encoders for functional safety technology: SIL2 (IEC 61508), SILCL2 (EN 62061), PL d (EN ISO 13849)
- Electrical interface: 4.5 V ... 32 V; sine/cosine 1 V_{pp}; 1,024 periods
- Clamping flange or servo flange, blind hollow shaft or through hollow shaft (assembly options with feather key)
- Universal cable outlet, M23 or M12 male connector, axial or radial
- Enclosure rating: IP 65
- Working temperature range: -30°C ... +95°C (depending on type)

Your benefits

- Certified safety products ensuring the best possible protection for persons, machinery, and systems
- Easy and practical handling of safety functions with all-in-one solutions from a single source, safety functions with the Flexi Soft drive monitor by SICK: safe stop 1 (SS1), safe stop 2 (SS2), safe operating stop (SOS), safe speed monitoring (SSM), safely limited speed (SLS), safe direction (SDI), safe brake control (SBC)
- Force fit and tight fit for mechanical reliability
- Certified safety products instead of standard products reduce the scope of safety engineering
- Versatile connection options for high levels of flexibility and straightforward implementation
- Compact installation depth for compatibility with applications in which installation space is limited

→ www.sick.com/DFS60S_Pro

For more information, simply enter the link or scan the QR code and get direct access to technical data, CAD design models, operating instructions, software, application examples, and much more.



AFx60S Pro – At a glance

- Absolute encoder for functional safety
- SIL3 (IEC 61508), SILCL3 (EN 62061), PL e (EN ISO 13849)
- Singleturn/multiturn encoder with up to 30 bit resolution
- Electrical interface: SSI + Sin/Cos – programmable
- Face mount flange or servo flange, blind hollow shaft or through hollow shaft (assembly options with feather key)
- Cable connection, M23 or M12 male connector, axial or radial
- Operating temperature range: -30 °C ... 95 °C

Your benefits

- Optimum protection for persons, machines and plants due certified safety product
- Easy and practicable handling of safety functions with complete safety solution from single source (safety functions with SICK Drive Monitor: safe stop 1 (SS1), safe stop 2 (SS2), safe operating stop (SOS), safe speed monitor (SSM), safely-limited speed (SLS), safe direction (SDI), safe brake control (SBC), safely-limited position (SLP)
- Positive and non-positive connections for mechanical reliability
- Certified safety products reduce the scope of safety engineering
- Versatile connection options for high levels of flexibility and straightforward implementation
- Compact size for compatibility with applications in which installation space is limited

→ www.sick.com/AFx60S_Pro

For more information, simply enter the link or scan the QR code and get direct access to technical data, CAD design models, operating instructions, software, application examples, and much more.





EKS/EKM36 – At a glance

- Motor feedback system with HIPERFACE DSL® interface
- Compact, robust design with 36 mm diameter
- Up to 20 bit resolution per revolution and 4,096 revolutions measurable with the multiturn system
- Facility for connecting an external temperature sensor
- E²Prom with 8 kbyte of free memory space
- SIL2-certified (only valid for EKS/EKM36-2...)
- Service life histogram

Your benefits

- Saving all analog components on the controller part through exclusively digital data transmission
- Enormous cost saving thanks to the separate encoder cable no longer being necessary, data transmitted synchronously to the controller cycle
- Minimal cabling thanks to integration of the encoder communication into the motor cable
- Optimization of the controller circuit via automated synchronization with the controller cycle

→ www.sick.com/EKS_EKM36

For more information, simply enter the link or scan the QR code and get direct access to technical data, CAD design models, operating instructions, software, application examples, and much more.



Lector62x – At a glance

- Decoding of all common 1D, 2D, and stacked codes, as well as optical character recognition (depending on type)
- Flexible interfaces: serial interface, USB, and Ethernet
- Function buttons, aiming laser, focus adjustment, auto-setup, and green feedback LED
- Industrial, compact housing with swivel connector
- MicroSD memory card for storing images and backup copies of parameters

Your benefits

- Intelligent decoding algorithms ensure optimal reading performance, good read rates, and high throughput
- 4Dpro facilitates quick and easy integration into many industrial networks
- Intuitive setup with aiming laser, focus adjustment, and auto-setup reduces training and installation time and costs
- Simple mounting thanks to a compact housing and swivel connector, even when space is limited
- Quick and efficient analysis of reading performance and code quality
- Cloning systems create backup copies of parameters, ensuring short machine downtimes in the event of malfunctions
- Proven SICK LifeTime Services



→ www.sick.com/Lector62x

For more information, simply enter the link or scan the QR code and get direct access to technical data, CAD design models, operating instructions, software, application examples, and much more.





Lector63x – At a glance

- Code reader with 2-megapixel sensor
- Flexible optics and filter design
- Integrated, replaceable high-power illumination
- Intuitive user interface, with flexible result string with code analysis options
- Function buttons, aiming laser, acoustic feedback signal, and green feedback LED
- microSD memory card

Your benefits

- High-resolution sensor and intelligent processing ensure outstanding reading performance, even under difficult reading conditions
- Flexible optical design and high-power illumination enable small codes to be read at high speeds or in applications with a large reading distance
- Fast, straightforward commissioning thanks to the intuitive user interface; function button for rapid device setup; integrated illumination and aiming laser
- Direct results monitoring thanks to acoustic signal and colored feedback spot on the object
- Few machine downtimes in the event of faults on the production line, thanks to straightforward cloning function using microSD memory card

→ www.sick.com/Lector63x

For more information, simply enter the link or scan the QR code and get direct access to technical data, CAD design models, operating instructions, software, application examples, and much more.



CLV64x – At a glance

- Dynamic focus adjustment enables extended depth of field
- Integrated function buttons, e. g., for starting auto setup or reading quality evaluation
- CAN, Ethernet TCP/IP, PROFINET, and EtherNet/IP on board. No additional Ethernet gateway required (for “Ethernet” connection type)
- Enhanced SMART code reconstruction technology
- Flexible sorting, filtering, and logical functions
- Advanced, easy-to-use SOPAS configuration software
- Integrated LED bar graph
- Advanced remote diagnostics and network monitoring capabilities available over Ethernet

Your benefits

- Economical, as only one CLV64x is required for all focus positions
- Intelligent auto setup and multi-function pushbuttons save time during commissioning
- Teach-in of match code possible via the pushbuttons
- Easily execute firmware updates using the microSD memory card: no need for a PC
- No supplementary Ethernet gateway required with Ethernet models – lowers costs
- Enhanced SMART technology reads damaged and partially obscured codes, increasing read rates
- Increased scanner intelligence enables sophisticated configuration of logical operations, reducing the control system programming effort. Data is then delivered in the desired format
- Real-time code identification even at very high conveyor speeds

→ www.sick.com/CLV64x

For more information, simply enter the link or scan the QR code and get direct access to technical data, CAD design models, operating instructions, software, application examples, and much more.





RFU62x – At a glance

- Compact UHF RFID read/write device with integrated antenna for sensing ranges of up to 1 m
- Standard-compatible transponder interface (ISO/IEC 18000-6C / EPC C1G2)
- Supports industry-standard data interfaces and fieldbuses, as well as PoE
- MicroSD memory card for parameter cloning
- Extensive diagnostic and service functions

Your benefits

- Correct assignment and no overshoot thanks to the well-defined read/write range and intelligent filter functions
- Integrated process logic for remote solutions saves additional control and programming effort
- Can be easily integrated into industrial networks thanks to 4Dpro compatibility
- Firmware upgrades and industry-standard compliance ensure long-term reliability
- Minimum changeover times in case of failure thanks to cloning
- RFU62x can be mounted to metal directly – no loss of range
- Easy operation and installation with SOPAS ET user interface

→ www.sick.com/RFU62x

For more information, simply enter the link or scan the QR code and get direct access to technical data, CAD design models, operating instructions, software, application examples, and much more.



RFU63x – At a glance

- UHF RFID read/write unit for industrial applications
- With or without integrated antenna, depending on the type (up to four external antennas can be connected)
- Standard-compliant transponder interface (ISO/IEC 18000-6C/EPC G2C1)
- Supports common industrial data interfaces and fieldbuses
- MicroSD memory card for device parameter cloning
- Several diagnostic and service options available

Your benefits

- Intelligent technology allows stand-alone usage
- Highest reading/writing performance
- Flexible integration in common industrial fieldbuses via 4Dpro compatibility
- Less maintenance time due to an integrated cloning back-up system using microSD memory card
- Easily adapts to application requirements via SOPAS parameter setting tool
- Free usable feedback LED quickly provides read results and diagnostic information directly to the user

→ www.sick.com/RFU63x

For more information, simply enter the link or scan the QR code and get direct access to technical data, CAD design models, operating instructions, software, application examples, and much more.





IDM14x – At a glance

- Reading distance up to 850 mm
- Identifies all popular linear bar codes
- Scan rate up to 500 scans/second
- Withstands 24 drops from 1.8 m height
- Highly visible scan line
- IP 41 enclosure rating

Your benefits

- Increased productivity thanks to high scan rate
- Reliable identification reduces the need to manually input data
- Lightweight, ergonomic design ensures user comfort
- Highly dependable thanks to rugged housing and non-moving parts
- Easy targeting with highly visible scan line for correct aiming

→ www.sick.com/IDM14x

For more information, simply enter the link or scan the QR code and get direct access to technical data, CAD design models, operating instructions, software, application examples, and much more.



IDM26x – At a glance

- Identification of all current 1D, stacked, and 2D codes
- Reliable, secure, and fast code reading
- Rugged, stable housing with IP 65 enclosure rating
- Supports all common corded and cordless interfaces as well as industrial fieldbuses via SICK connectivity
- Good read feedback via LED, beeper, and vibration
- Decoding algorithms ideal for direct part marked codes (depending on type)

Your benefits

- Only one device for a wide range of different code types
- Fast and accurate identification without manual data entry
- Highly reliable thanks to industrial enclosure rating and rugged housing
- Simple and flexible integration in industrial fieldbus networks using SICK connectors
- Simple, intuitive operation thanks to multiple read confirmation
- Direct expert advice all over the world from the SICK sales and service network
- Low contrast or highly reflective DPM codes are identified reliably

→ www.sick.com/IDM26x

For more information, simply enter the link or scan the QR code and get direct access to technical data, CAD design models, operating instructions, software, application examples, and much more.





Inspector – At a glance

- High-speed positioning, inspection and measuring
- Powerful “object locator” tool, independent of position, rotation and scale
- Unique, interchangeable housing design supporting dome and various optical accessories
- Simple step-by-step configuration in PC including emulator
- Easy-to-use operator interfaces
- Flexible machine and HMI design interfaces

Your benefits

- The multi-functional vision toolbox offers smart camera-level performance but with sensor ease-of-use
- Unique, interchangeable housing design provides the easiest way to improve image quality
- The simple configuration in SOPAS, including emulator for offline configuration and testing, will reduce downtimes in production to a minimum
- The easy-to-use operator interfaces are optimized to make it easier for the operator to oversee daily work more efficiently
- Ethernet communication and web API gives excellent connectivity and freedom to customize user’s HMI

→ www.sick.com/Inspector

For more information, simply enter the link or scan the QR code and get direct access to technical data, CAD design models, operating instructions, software, application examples, and much more.



InspectorP63x – At a glance

- 1.3 and 1.9 MP programmable 2D cameras
- Flexible S- and C-mount lenses and integrated illumination
- 4Dpro interfaces
- Aiming laser, beeper and feedback spot
- Powered by HALCON 12 library
- Scripted in SICK AppStudio
- Web operator interface

Your benefits

- SICK AppSpace development framework offers full software flexibility for tailored solutions
- World-leading HALCON 12 library runtime license included
- Fast, high-resolution programmable 2D cameras ensure maximum performance
- Flexible optical design enables analysis of small features at high speeds
- Unique operator interaction possibilities thanks to powerful set of convenience features
- Smooth commissioning with customized operator interface and SICK AppManager

→ www.sick.com/InspectorP63x

For more information, simply enter the link or scan the QR code and get direct access to technical data, CAD design models, operating instructions, software, application examples, and much more.





TriSpector1000 – At a glance

- 3D inspection of moving parts
- Intuitive user interface
- Embedded image analysis
- Easy replacement concept
- High resolution 3D image with intensity overlay
- Factory calibrated 3D data, true mm values in all dimensions
- Rugged IP67 metal housing

Your benefits

- Reliable 3D inspection even when part color, position and height varies
- Easy commissioning and operation thanks to an intuitive user interface
- Embedded image analysis for fast configuration
- Quick device replacement due to guaranteed field of view and re-use of saved settings
- Intensity data enhances 3D navigation, allows checking presence of label, printed pattern or object rotation.
- Factory calibrated data simplifies setup and reduces time and effort
- Withstands harsh or food processing environments

→ www.sick.com/TriSpector1000

For more information, simply enter the link or scan the QR code and get direct access to technical data, CAD design models, operating instructions, software, application examples, and much more.



IVC-3D – At a glance

- Easy 3D measurement – provides information about object height, shape and volume
- Independent of object contrast and color
- Easy-to-use graphical user interface for fast application development
- Simple connection of PLCs, robots, and other control systems, e.g., those using Ethernet/IP or OPC
- Scans up to 5,000 profiles per second
- Industrial, rugged metal housing

Your benefits

- The IVC-3D makes advanced 3D shape inspections easy, enabling cost-efficient solutions
- Contrast-independent measurement provides greater reliability even at varying object color and when the object color is the same as the background
- Factory calibrated – instantly providing true metric dimensions at production speed
- The camera's OPC server and EtherNet/IP interface enables simple communication with PLCs, robots and control systems, making integration easy
- Stand-alone operation – no PC is needed after configuration

→ www.sick.com/IVC-3D

For more information, simply enter the link or scan the QR code and get direct access to technical data, CAD design models, operating instructions, software, application examples, and much more.



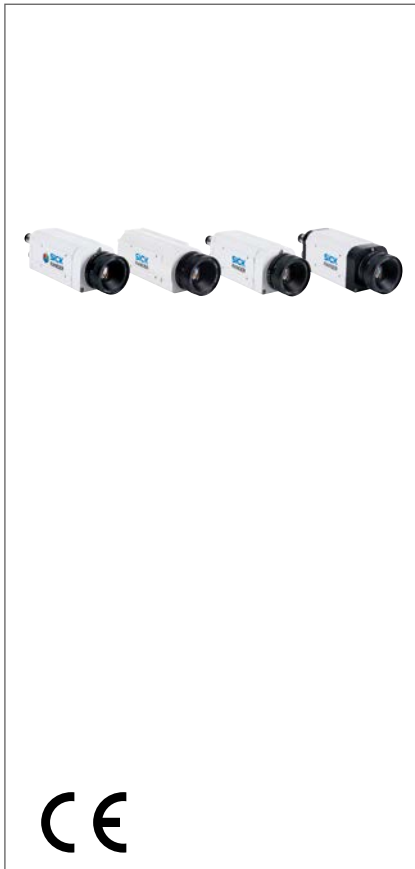

Ranger – At a glance

- Fast 3D measurement at high speed and quality
- MultiScan function for simultaneously measuring the 3D shape, contrast, color, and scatter
- Sensor resolutions of up to 1,536 pixels in 3D and 3,072 pixels in grayscale and color
- High levels of flexibility in configuration, working distance, and field of view
- In-machine 3D calibration
- Gigabit Ethernet and CameraLink interfaces

Your benefits

- High-speed and high-resolution measurements allow you to increase production throughput, and still see fine details, thus ensuring production quality.
- Get accurate size and position measurements in 3D regardless of an object's height or color, ensuring reliable solutions
- High levels of flexibility in the field of view combined with the in-machine 3D calibration concept provides true millimeter dimensions
- Unique MultiScan technology enables one camera to do the work of many, reducing costs for integration, maintenance, and accessories, and creating cost-efficient solutions.
- The high level of flexibility and versatility of the Ranger makes it the ideal choice for challenging tasks

→ www.sick.com/Ranger

For more information, simply enter the link or scan the QR code and get direct access to technical data, CAD design models, operating instructions, software, application examples, and much more.



Visionary-T – At a glance

- Record up to 30 3D images per second
- Distance values: 144 x 176 pixels per snapshot
- Output 3D data via a Gigabit Ethernet interface
- Depth reproducibility of 3 mm and 30 mm at 1 m and 7 m distances respectively
- Temperature range: 0 °C to 50 °C or up to 45 °C (depending on the housing), Enclosure rating: IP67; light sensitivity: 0 klx ... 50 klx

Your benefits

- More than 25,000 distance and intensity values in a single recording. As a result, no actuator is required and 3D information is also available for stationary applications.
- Easy mounting and rapid sensor replacement
- Solutions which provide the exact information required for the application
- Programming interface for using 3D data for further analysis on an external host
- The Visionary-T AG product version supports intelligent data reduction

→ www.sick.com/Visionary-T

For more information, simply enter the link or scan the QR code and get direct access to technical data, CAD design models, operating instructions, software, application examples, and much more.





SIM4000 – At a glance

- Wide range of connections with 25 interfaces for Ethernet-based fieldbuses, cameras, illumination, sensors, encoders, and more besides
- 8-gigabit Ethernet interfaces for rapid image transmission
- Precise synchronization of input and output signals
- Illumination control and supply
- IO-Link master connections
- Enclosure rating IP 65

Your benefits

- Tailored application development with SICK AppSpace
- High-performance, innovative application solutions through merging of sensor and camera data
- The integrated HALCON library opens up a whole host of image processing possibilities for every industrial field of application
- Recording, evaluation, and archiving of data from multiple cameras and sensors, enabling quality control, process analysis, and predictive maintenance for vertical integration in Industry 4.0
- Real-time-capable hardware reduces integration work in, for example, time-critical robotics applications
- Quick and easy commissioning thanks to prefabricated cables with M12 connections

→ www.sick.com/SIM4000

For more information, simply enter the link or scan the QR code and get direct access to technical data, CAD design models, operating instructions, software, application examples, and much more.



OD Mini – At a glance

- Compact, rugged housing
- Stand-alone use or in combination with the OD Mini evaluation unit
- Display and LEDs on device for visualization of current status
- Different interfaces available
- Simple teach-in using display or external teaching input
- CMOS receiver unit for precise, fast measurement in the μm range
- Various measuring ranges: Measuring from 10 mm to 250 mm possible

Your benefits

- Cost-saving commissioning through simple operating concept and display
- Small installation size and low weight also allow use in highly dynamic applications
- Calculation of two sensorheads - easy possible over the external evaluation unit
- High machine throughput thanks to reliable measurement, regardless of brightness and color of surface
- The wide range of available interfaces enables simple integration into industrial networks
- Optimum performance even at high production speeds

→ www.sick.com/OD_Mini

For more information, simply enter the link or scan the QR code and get direct access to technical data, CAD design models, operating instructions, software, application examples, and much more.





OD1000 – At a glance

- Large measuring range of up to 1 m
- Simple setting via OLED display or SOPAS configuration software
- Standalone device without external amplifier unit
- Rugged metal housing
- Adjustable analog output (mA/V) and push-pull switching output with IO-Link
- Precise measurement regardless of color or surface
- Versatile mounting possibilities

Your benefits

- Optimization of the process quality due to high precision and linearity over the entire measuring range
- Quick commissioning due to variable mounting and innovative operating concept
- Simple and cost-saving integration via OLED display and IO-Link interface
- Suitable for harsh ambient condition due to rugged metal housing
- High machine availability thanks to reliable, quick, and precise measurement results on a wide range of surfaces
- Intelligent measured value filter and analysis algorithm for safe and stable measurement in every application

→ www.sick.com/OD1000

For more information, simply enter the link or scan the QR code and get direct access to technical data, CAD design models, operating instructions, software, application examples, and much more.



DT20 Hi – At a glance

- Four measuring ranges from 50 mm up to 1,000 mm
- Very high linearity of up to ± 0.5 mm
- CMOS receiving element enables accurate distance measurement independent of color or shininess
- Red laser
- Scaleable analog and switching output
- Display with easy to use setup menu
- Advanced settings (e.g., averaging function, external laser-off, etc.)

Your benefits

- Reliable, precise measurement, independent of surface, increases production quality
- Reliable and consistent measurements, regardless of color, reduce changeover time
- Advanced settings provide increased application flexibility to easily solve customer-specific applications
- Fast commissioning via button, remote or numerical teach
- Easy, precise alignment and verification based on red laser light and LC display, decreasing commissioning time
- Tough metal housing permits operation in harsh environments

→ www.sick.com/DT20_Hi

For more information, simply enter the link or scan the QR code and get direct access to technical data, CAD design models, operating instructions, software, application examples, and much more.





Dx35 – At a glance

- Maximum reliability, immunity to ambient light, and best price/performance ratio thanks to HDDM™ technology
- Measuring range of 0.05 m to 12 m for natural objects or 0.2 m to 35 m on reflective tape
- Devices with analog and switching output, or just switching
- Infrared or red laser in class 1 or class 2
- Repeatability: 0.5 mm to 5 mm
- Small housing size
- IO-Link

Your benefits

- Precise and reliable measurement regardless of object color extends run time and process quality
- A small size and blind zone make flexible mounting possible when space is limited
- Optimum solution thanks to flexible settings for speed, range and repeatability
- Flexible interface use: 4 mA to 20 mA, 0 V to 10 V, PNP output, NPN output, or IO-Link – making machine integration simple
- Offering easy alignment, optimal performance or inconspicuous measurement, versatile light senders make it an ideal solution for all scenarios
- Low investment costs and high performance levels guarantee a quick return on investment
- IO-Link offers full process control, from commissioning to service
- A wide variety of control options ensures rapid commissioning and fast batch changes

→ www.sick.com/Dx35

For more information, simply enter the link or scan the QR code and get direct access to technical data, CAD design models, operating instructions, software, application examples, and much more.



Dx50 – At a glance

- HDDM™ technology offers best reliability, immunity to ambient light and price/performance ratio
- Measurement ranges of 10 m or 20 m directly onto the object or even 50 m on reflector
- Different performance levels depending on product and laser class chosen
- Different interfaces: switching, analog or serial interface
- Display with intuitive and consistent operating concept
- Robust die-cast zinc metal housing
- Operating temperature from -30 °C to +65 °C

Your benefits

- Wide measurement ranges up to 10, 20 or 50 m in combination with different interfaces allow an easy and fast integration in any production environment
- Highly reliable and precise measurement helps to increase process quality and stability
- High measurement or switching frequencies enable a fast material flow
- Dx50 product family is based on a common platform, offering multiple performance levels, making it easy to accommodate future changes
- Intuitive setup via display or remote teach reduces installation time and costs
- Temperature range from -30 °C to +65 °C allows for outdoor use without additional cooling or heating
- Up to 40 klx ambient light immunity – allows for use in optically challenging environments

→ www.sick.com/Dx50

For more information, simply enter the link or scan the QR code and get direct access to technical data, CAD design models, operating instructions, software, application examples, and much more.





UM30 – At a glance

- Integrated time-of-flight technology detects objects such as glass, liquids and transparent foils, independent of color
- Range up to 8,000 mm
- Display enables fast and flexible sensor adjustment
- Immune to dust, dirt and fog
- Available with combined analog and digital outputs
- Synchronization and multiplexing
- Adjustable sensitivity
- Three operation modes: Distance to Object (DtO), Window (Wnd) or Object between sensor and background (ObSB)

Your benefits

- Easy machine integration due to compact size
- Various setup options ensure flexible adaptation to applications
- Multiplex mode eliminates crosstalk interference for consistent and reliable detection and high measurement reliability
- Synchronization mode allows multiple sensors to work as one large sensor, providing a low-cost solution for area detection
- Display enables setup prior to installation, reducing on-site installation time
- Integrated temperature compensation and time-of-flight technology ensure high measurement accuracy
- ObSB-mode enables detection of any object between the sensor and a taught background

→ www.sick.com/UM30

For more information, simply enter the link or scan the QR code and get direct access to technical data, CAD design models, operating instructions, software, application examples, and much more.



UM18 – At a glance

- Reliable measurement independent of material color, transparency, gloss and ambient light
- Four ranges up to 1,300 mm
- Short metal or plastic M18 housing with a length of 41 mm
- Straight or right-angle version
- High immunity to dirt, dust, humidity and fog
- PNP/NPN switching output, analog output or push-pull switching output with IO-Link
- Synchronization and multiplex modes are available

Your benefits

- Four sensing ranges up to 1,300 mm provide a range of flexible mounting options
- Easy machine integration due to short M18 housing available in straight or right-angle versions
- Intelligent measurement filters and versions with temperature compensation guarantee reliable measurement results for maximum process reliability
- Solid, one-piece housing secures highest machine availability
- Synchronization or multiplex mode enables simultaneous operation of up to 10 sensors, improving application flexibility and process reliability
- Easy system integration due to a wide range of available output signals
- Unintentional adjustments to sensor settings are eliminated since teach-in process is done with an external wire
- Variety of application solutions due to insensitivity and reliability of ultrasound technology

→ www.sick.com/UM18

For more information, simply enter the link or scan the QR code and get direct access to technical data, CAD design models, operating instructions, software, application examples, and much more.





UC4 – At a glance

- Reliable measurement, regardless of material color, transparency, gloss, or ambient light
- Ultrasonic technology in a small housing
- Detection, measurement, and positioning with ultrasonic technology
- Variants with PNP/NPN switching output, analog output or push-pull output with IO-Link
- Teach-in button
- Precise background suppression
- Immune to dirt, dust, humidity, and fog

Your benefits

- Mini housing allows for quick and easy integration, even in the most confined spaces
- Teach-in button for fast and easy commissioning
- Integrated temperature compensation ensures high measurement accuracy at all times for optimum process quality
- Various operating modes provide optimal application flexibility and solutions, which increase reliability and productivity
- Full mechanical compatibility to photoelectric sensors allows for the use of the suitable technology for every application without machine modification
- The sensor's immunity to optically difficult environment enables it to take accurate measurements even in dirty, dusty, humid, and foggy conditions

→ www.sick.com/UC4

For more information, simply enter the link or scan the QR code and get direct access to technical data, CAD design models, operating instructions, software, application examples, and much more.



UD18 – At a glance

- Material classifications: no layers, single layer, double layers
- Plug-and-play; sensitivity levels that can be selected, taught in, and changed during operation
- Up to four individual sensitivity levels
- Variable mounting distance
- LEDs visible from any direction
- Immune to dirt, dust, and humidity

Your benefits

- Maximum productivity and quality thanks to reliable material transportation monitoring
- Rapid commissioning thanks to plug-and-play plus a range of sensitivity levels to choose from
- Easy to switch between sensitivity levels during operation, preventing downtimes during material changes
- Individual teach-in of various materials, making it possible to tackle even the most demanding applications
- The utmost flexibility during installation thanks to variable mounting distance
- LEDs visible from any direction, making it easy to monitor double sheet detections
- Reliable detection in dirty, dusty, and humid conditions thanks to the ultrasonic technology's immunity to these environments

→ www.sick.com/UD18

For more information, simply enter the link or scan the QR code and get direct access to technical data, CAD design models, operating instructions, software, application examples, and much more.





TiM5xx – At a glance

- Monitoring area of up to 1,470 m² with just one sensor
- High ambient light tolerance due to HDDM technology
- Rugged housing with up to an IP 67 enclosure rating
- Low power consumption (typ. 4 W)
- Compact design with a housing height of just 86 mm maximum
- Integrated Ethernet interface
- Long sensing range of up to max. 25 m
- Industry-standard design and M12 male connector

Your benefits

- Reliable object detection independent of the surface and ambient light
- Rugged IP 67 enclosure rating withstands both indoor and outdoor conditions
- Easy integration into compact automated guided vehicles (AGV) due to small size
- Ethernet interface enables straightforward implementation and remote maintenance
- Can determine additional information such as object size, shape, etc. due to measured data output
- Low implementation costs due to scalability: Sensor telegram is identical to sensor telegrams for laser scanners in the SICK portfolio

→ www.sick.com/TiM5xx

For more information, simply enter the link or scan the QR code and get direct access to technical data, CAD design models, operating instructions, software, application examples, and much more.



LMS4xx – At a glance

- The “Level Control” application integrated in the sensor is, with its gapless scanning surface, able to perform “shadowless” detection of objects in containers. Even small objects, regardless of color, are detected anywhere in the container.
- Large dynamic measurement range of 0.7 m to 3 m
- Rugged design
- High angular resolution and scanning frequency
- Ideal for depalletizing tasks, contour verification and vision applications on pallets

Your benefits

- The integrated Level Control feature replaces a number of sensors and drastically reduces the effort required for wiring and programming
- Reliable detection at high conveyor speeds
- Neither shading nor artificial lighting is necessary
- Mounting is possible in positions beyond the robot collision area
- Fast data acquisition thanks to highly precise detection and positioning measurements in real time

→ www.sick.com/LMS4xx

For more information, simply enter the link or scan the QR code and get direct access to technical data, CAD design models, operating instructions, software, application examples, and much more.





NAV2xx – At a glance

- Integrated data evaluation for determining reflector positions
- Scanning range of up to 30 m on reflectors, up to 18 m on black (10 % remission), maximum of up to 50 m
- Collection angle: 270°
- Scanning frequency: 25 Hz
- Angle resolution on reflectors: 0.001°
- Temperature resistant from -30 °C to +50 °C
- IP 67 enclosure rating and integrated heating

Your benefits

- Reliable position determination and navigation even in highly demanding environmental conditions, thanks to the IP 67 enclosure rating, integrated heating, and vibration resistance
- Compact size – suitable even for use in small vehicles
- Precise, fast collection of spatial contour data and/or simultaneous determination of reflector data in real time
- Integrated evaluation of measured data reduces computing load in the vehicle computer
- Excellent flexibility, as guided-track control is possible even in areas without reflector marks

→ www.sick.com/NAV2xx

For more information, simply enter the link or scan the QR code and get direct access to technical data, CAD design models, operating instructions, software, application examples, and much more.



NAV3xx – At a glance

- Mixed-mode navigation provides both spatial contour data and reflector data
- Long scanning range: up to 70 m on reflectors (up to 35 m on black targets)
- High internal computing power and individual AGV configuration
- Measurement, navigation, and determination of position with highest level of precision from three visible reflectors
- Angular resolution of up to 0.1 degrees
- Navigation, spatial and contour data, reflector marks, angular position and/or raw data collection

Your benefits

- Precise, fast collection of spatial contour data and/or simultaneous determination of reflector data (managing up to 12,000 reflectors) in real time
- Integrated evaluation of measured data reduces the computing load in the vehicle computer, minimizing power consumption and reducing operating costs
- High flexibility, since line guidance is also possible in areas without reflector marks, and routes can be easily modified using teach-in mode
- Precise measurements in harsh industrial environments thanks to IP65 housing for indoor applications
- High angular resolution for gap-free scanning even under difficult conditions
- Hardware synchronization output ensures precise control

→ www.sick.com/NAV3xx

For more information, simply enter the link or scan the QR code and get direct access to technical data, CAD design models, operating instructions, software, application examples, and much more.





LFP Inox – At a glance

- Level measurement in hygienic applications
- Rod probe can be cut to length manually up to 4,000 mm long with $Ra \leq 0.8 \mu m$
- Process temperature up to 180 °C, process pressure up to 16 bar
- CIP/SIP-resistant
- High enclosure rating: IP 67 and IP 69K, autoclavable
- Interchangeable hygienic process connections
- 3 in 1: combines display, analog output, and binary output
- Remote amplifier with process connection
- IO-Link 1.1

Your benefits

- Rugged design increases service life
- High flexibility – rod probe can be cut to length and connection concept is interchangeable
- Cost savings as a result of multiple output signals: one system for both point level and continuous level measurement
- Maintenance-free and easy to commission without calibration, saving time and money
- Remote display of measured values and saves space

→ www.sick.com/LFP_Inox

For more information, simply enter the link or scan the QR code and get direct access to technical data, CAD design models, operating instructions, software, application examples, and much more.



LFV200 – At a glance

- Housing made of 316L stainless steel
- Two electrical output versions available
- Commissioning without filling
- Process temperature up to 150 °C
- Immune to deposit formation
- Very high repeatability
- Aseptic versions with polished surface, CIP and SIP resistant
- Tube extension up to 1,200 mm

Your benefits

- Easy installation and commissioning, no pre-calibration necessary
- Easy operation and integration
- Maintenance-free system
- Sensors can be tested while installed
- Flexible, reliable system suitable for many types of applications
- Universal technology works in all kinds of liquids
- Economical solution for vertical mounting
- Can be used in containers and pipes regardless of installation conditions

→ www.sick.com/LFV200

For more information, simply enter the link or scan the QR code and get direct access to technical data, CAD design models, operating instructions, software, application examples, and much more.





MHF15 – At a glance

- Robust level monitoring in liquid without additional requirements
- Small, compact design; no medium calibration required
- Process temperature up to 55 °C, process pressure up to 16 bar
- IP 67 and IP 69K enclosure rating
- Process connection G ½
- Highly medium resistant due to stainless steel housing 1.4404, polysulfone apex
- Output available as PNP or NPN transistor
- FDA-compliant, UL

Your benefits

- Small, compact sensor ideal for difficult installation conditions with limited space
- Quick commissioning without medium calibration saves time and money
- No moving mechanical parts reduce maintenance and eliminate the need to recalibrate, even after long periods of use.



→ www.sick.com/MHF15

For more information, simply enter the link or scan the QR code and get direct access to technical data, CAD design models, operating instructions, software, application examples, and much more.



PBS Hygienic – At a glance

- Hygienically-graded pressure switch with display for the food and beverage industry
- Wetted parts are made from stainless steel 1.4435
- Individually programmable switching outputs and analog output
- Pressure values are indicated on the display
- Unit of pressure value in the display can be switched
- Output states are indicated separately via large LEDs
- IO-Link

Your benefits

- Safe hygienic operation due to flush-mounted, highly resistant stainless steel membrane and hygienic process connections
- Suitability for CIP and SIP ensures high system availability
- Safe and easy setup with three large pushbuttons and legible, rotatable display
- Rotatable housing for optimum cable routing
- Wide range of available configurations enable customer-specific solutions
- High reliability: Corrosion-resistant design of wetted parts and housing with IP 65 and IP 67 enclosure ratings
- Ultimate system availability: IO-Link enables fast, reliable parameter setting when changing over products



→ www.sick.com/PBS_Hygienic

For more information, simply enter the link or scan the QR code and get direct access to technical data, CAD design models, operating instructions, software, application examples, and much more.





PAC50 – At a glance

- Electronic pressure switch for pneumatic applications
- Large display shows system pressure, output states and set switching points
- Three large function keys and intuitive menu navigation
- Measuring range for gauge pressure (vacuum and overpressure)
- Individually programmable switching outputs and optional analog output
- Installation on a mounting rail, wall or in a control panel
- IO-Link

Your benefits

- Bi-color display (green/red) clearly shows the output state to recognize whether the pressure is within the target range
- Quick overview of important system parameters due to advanced display functions
- Intuitive operation allows simple and quick commissioning
- Pressure connections on the back and bottom, various mounting options and configurable output signals provide installation flexibility
- High reliability due to the rugged design (IP 65/IP 67 enclosure rating) and proven technology
- Low storage costs since a few product variants are able to meet a broad range of application requirements
- Reduced downtime when changing the format or replacing the sensor thanks to IO-Link

→ www.sick.com/PAC50

For more information, simply enter the link or scan the QR code and get direct access to technical data, CAD design models, operating instructions, software, application examples, and much more.



PHT – At a glance

- Robust and precise pressure measurement technology
- Flush-mounted, hermetically sealed stainless steel membrane with roughness Ra < 0.4 μm
- Wetted parts stainless steel 1.4435, housing stainless steel 1.4571
- CIP/SIP resistant
- Large range of hygienic process connectors
- Stainless steel housing with enclosure rating of up to IP 68
- Field housing available (IP 67)

Your benefits

- Perfectly suited for demanding hygienic applications in the food and beverage, pharmaceutical and cosmetics industries
- Safe hygienic operation through EHEDG and 3-A certifications
- High reliability due to robust design and use of high-grade materials
- Withstands CIP/SIP, ensuring high system availability and reliability
- Transmitter housing is easily cleaned
- Versatile configurability optimizes solutions

→ www.sick.com/PHT

For more information, simply enter the link or scan the QR code and get direct access to technical data, CAD design models, operating instructions, software, application examples, and much more.





FFU – At a glance

- Flow sensor for conductive and non-conductive liquids
- Compact design with no moving parts
- Process temperature up to 80 °C, process pressure up to 16 bar
- High chemical resistance due to seal-free sensor design
- Large display with membrane keyboard
- Integrated empty tube detection

Your benefits

- Maintenance-free flow sensor; reduces maintenance costs
- Adjustable measuring ranges, reduced number of variants
- Can be used for conductive and non-conductive liquids, reducing both the number of variants and storage costs
- Straight measuring tube reduces pressure loss, thus reducing energy costs
- Sensor without seals increases process reliability and availability
- Flexible measuring device for all industries

→ www.sick.com/FFU

For more information, simply enter the link or scan the QR code and get direct access to technical data, CAD design models, operating instructions, software, application examples, and much more.



DOSIC® – At a glance

- Flow measurement for water and oil-based liquids
- Seal-free stainless-steel 316L sensor with Ra ≤ 0.8
- Straight, self-draining measuring tube
- Compact design with short installation lengths
- Configurable digital outputs
- Temperature measurement
- IP 67/69 enclosure rating, CIP/SIP-compatible, IO-Link version 1.1

Your benefits

- Flexible measurement system for all industries and liquids
- Versatile use for conductive and non-conductive liquids and temperature measurement
- Short installation lengths and a compact design enable installation in applications with limited space
- Food-safe thanks to rust-free stainless steel and hygienic design
- Quick installation without medium calibration
- User-friendly application thanks to rotatable housing and display
- Straight measuring tube reduces pressure loss, thus reducing energy costs

→ www.sick.com/DOSIC

For more information, simply enter the link or scan the QR code and get direct access to technical data, CAD design models, operating instructions, software, application examples, and much more.



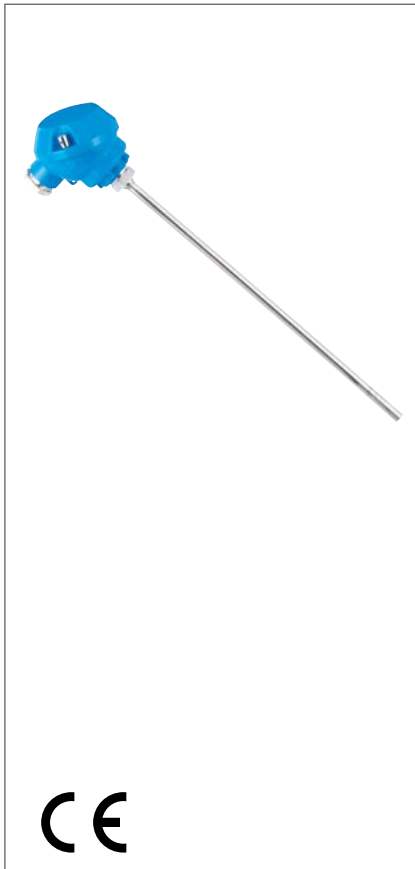

TBT – At a glance

- Pt100 element, accuracy class A according to IEC 60751
- Measuring ranges $-50\text{ °C} \dots +150\text{ °C}$ and $-50\text{ °C} \dots +250\text{ °C}$
- Wetted parts made from corrosion resistant stainless steel 1.4571
- Various mechanical adaptations and insertion lengths
- Pt100 (4-wire) or 4 mA ... 20 mA (2-wire)
- Cable gland M16 x 1.5

Your benefits

- Reliable operation through rugged design and high-quality materials
- Very good long-term stability, accuracy and linearity
- Quick and safe installation
- Convenient system integration even in narrow installation spaces
- Optimal solutions for individual requirements due to versatile configurability

→ www.sick.com/TBT

For more information, simply enter the link or scan the QR code and get direct access to technical data, CAD design models, operating instructions, software, application examples, and much more.



TCT – At a glance

- Pt100 element, accuracy class A according to IEC 60751
- Measuring ranges $-50\text{ °C} \dots +150\text{ °C}$ and $-50\text{ °C} \dots +250\text{ °C}$
- Wetted parts made from corrosion resistant stainless steel 1.4571
- Various mechanical adaptations and insertion lengths, also available with thermowell
- Pt100 (4-wire) or 4 mA ... 20 mA (2-wire)
- Circular connector M12 x 1 (IP 67) or L-connector according to DIN EN 175301-803 A (IP 65)

Your benefits

- Reliable operation through rugged design and high-quality materials
- Very good long-term stability, accuracy and linearity
- Quick and safe installation
- Convenient system integration through compact dimensions and industry-standard output signals
- Optimal solutions for individual requirements due to versatile configurability

→ www.sick.com/TCT

For more information, simply enter the link or scan the QR code and get direct access to technical data, CAD design models, operating instructions, software, application examples, and much more.





THTS – At a glance

- Pt100 element, accuracy class A (IEC 60751)
- Measuring ranges $-50\text{ °C} \dots +150\text{ °C}$ and $-50\text{ °C} \dots +250\text{ °C}$
- Parts in contact with media: Corrosion-resistant stainless steel 316L/1.4435, $R_a \leq 0.8\text{ }\mu\text{m}$
- Various hygienic process connections and installation lengths
- Pt100 (4-conductor) or 4 mA ... 20 mA (2-conductor)
- M12 round connector x 1

Your benefits

- Convenient system integration – installation in narrow installation space possible through compact dimensions
- Safe, hygienic operation due to wetted parts made from high-grade stainless steel, hygienically-graded surface finish and a gap- and crevice-free design
- Rugged: Connection housing is easy to clean and splash-proof
- Quick and safe installation
- Very good long-term stability, accuracy and linearity
- Quick response time
- Optimal solutions for individual requirements due to versatile configurability

→ www.sick.com/THTS

For more information, simply enter the link or scan the QR code and get direct access to technical data, CAD design models, operating instructions, software, application examples, and much more.



THTE – At a glance

- Pt100, accuracy class A (IEC 60751)
- Measuring ranges $-50\text{ °C} \dots +150\text{ °C}$ and $-50\text{ °C} \dots +250\text{ °C}$
- Sensor probe spring-loaded in protective pipe
- Wetted parts: corrosion-resistant stainless steel 316L/1.4435, $R_a \leq 0.8\text{ }\mu\text{m}$
- Hygienic process connections
- Pt100 (4-conductor) or 4 mA ... 20 mA (2-conductor)
- M12 round connector x 1

Your benefits

- The sensor can be exchanged without opening the process, providing high equipment availability and minimizing hygienic risks
- Safe hygienic operation: Wetted parts are made from high-grade stainless steel, hygienically-graded surface finish, and a gap- and crevice-free design
- Rugged: Connection housing is easy to clean and splash water proof
- Quick and safe installation
- Very good long-term stability, accuracy and linearity
- Quick response time
- Optimal solutions for individual requirements due to versatile configurability

→ www.sick.com/THTE

For more information, simply enter the link or scan the QR code and get direct access to technical data, CAD design models, operating instructions, software, application examples, and much more.





CE

TRANSIC Extractive – At a glance

- Oxygen transmitter based on modern laser spectroscopy (TDLS)
- Compact design adapted to specific application conditions
- Very easy to operate and install
- Can be combined with sample point switching
- Flexible for virtually every application
- Modular extension possible

Your benefits

- Reliable measurement in difficult measuring conditions and in contaminated gases
- Slim sample conditioning system results in minimal maintenance work
- Can be used in hazardous areas
- Easy to use and install
- Low operating costs

→ www.sick.com/TRANSIC_Extractive

For more information, simply enter the link or scan the QR code and get direct access to technical data, CAD design models, operating instructions, software, application examples, and much more.



CE

Inline Code Matcher – At a glance

- Code comparison (1D/2D) during the production process
- Intuitive operation via HMI with touch display
- Easy-to-integrate stand-alone solution
- Statistic display and display of the last fault patterns
- Multi-track plants supported
- User-friendly batch change on the fly or with a hand-held scanner

Your benefits

- Reliable batch assignment for increased food safety – the right product in the right packaging
- Low overall costs thanks to simple installation and operation
- Easy retrofitting of existing plants thanks to stand-alone solution
- Product changes during the process for a high level of flexibility and short set-up times
- Maximum system throughput thanks to reliable code reading
- Process control through the display of crucial quality parameters

→ www.sick.com/Inline_Code_Matcher

For more information, simply enter the link or scan the QR code and get direct access to technical data, CAD design models, operating instructions, software, application examples, and much more.





Asset Monitoring System – At a glance

- Code reading to collect production data during operation
- Data export via configurable FTP connection
- Intuitive operation via HMI with touchscreen
- Easy-to-integrate stand-alone solution
- Display of live image and reading statistics

Your benefits

- Quality assurance through the evaluation of detailed equipment usage data
- Low overall costs thanks to simple installation and operation
- Trouble-free retrofitting of existing plants thanks to stand-alone solution
- Easy access to data thanks to automated export function

→ www.sick.com/Asset_Monitoring_System

For more information, simply enter the link or scan the QR code and get direct access to technical data, CAD design models, operating instructions, software, application examples, and much more.



VMS410/510 – At a glance

- Measures length, width and height of an object
- Calculation of the smallest enclosing cube (box volume)
- Optimized application software
- All measuring functions are built in the measuring head, no additional evaluation unit is required

Your benefits

- Simple mounting saves time on installation, commissioning, and provides flexibility for different application environments
- Compact design ensures easy integration into new and existing systems
- Low-maintenance system (short MTRR through plug & play unit exchange)
- Tested and certified to OIML, MID and further standards

→ www.sick.com/VMS410_510

For more information, simply enter the link or scan the QR code and get direct access to technical data, CAD design models, operating instructions, software, application examples, and much more.





VML – At a glance

- Measurement accuracy of up to 5 mm x 5 mm x 2.5 mm (L x W x H) at 1 m/s, and up to 5 mm x 5 mm x 5 mm (L x W x H) at 2 m/s.
- Maximum object size 2,600 mm x 1,200 mm x 1,200 mm (L x W x H)

- Protection class up to IP65
- High degree of integration thanks to the MSC800 controller

Your benefits

- Reliable measurement of objects, regardless of their surface properties – particularly transparent and very dark objects
- Accurate in-line measurement of objects

- Reliable measurement properties thanks to receiver and transmitter modules
- Short MTTR reduces maintenance, lowers operating costs and increases system throughput

→ www.sick.com/VML

For more information, simply enter the link or scan the QR code and get direct access to technical data, CAD design models, operating instructions, software, application examples, and much more.



Safeguard Detector – At a glance

- Certified up to SILCL2 (EN 62061), PL d (EN ISO 13849)
- Highly available sensors in miniature enclosure
- Secure detection of objects with a remission of 6% to 90%

- Detection range: maximum 100 mm
- Pulse frequency 2 Hz or 10 Hz
- Background and foreground suppression protects against manipulation
- Logic evaluation of redundant sensor signals

Your benefits

- Rugged sensors, flexible machine controller and reliable safety in one system
- Certified safety system saves time and costs. An additional safety assessment is not necessary.
- Less costs compared to complex mechanical protection
- Minimum space requirements thanks to an ultra-compact sensor enclosure

- Easily adaptable: Make format changeovers in no time
- Modular system: Facilitates retrofitting of older machines
- Secure investment: Control can be flexibly expanded and used for additional functions, e.g. filling level measurement of the carton magazine

→ www.sick.com/Safeguard_Detector

For more information, simply enter the link or scan the QR code and get direct access to technical data, CAD design models, operating instructions, software, application examples, and much more.





Hygienic design mounting system: because a hygienic design is just safer!

- Hygienic design according to EHEDG guidelines
- Optimal chemical resistance (through the use of silicone seals and V4A stainless steel [grade 1.4404/316L])
- FDA approved materials
- Quicker and safer sensor installation thanks to the bayonet mount
- Bayonet mount guarantees retention of optical alignment when sensors are replaced
- Flexible system for customized height and rotation alignment



→ www.sick.com/beftecHD

For more information, just enter the link or scan the QR code and get direct access to technical data, CAD design models, operating instructions, software, application examples and much more.



M12 PVC connection cables: nothing gets past them!

- The double active innovative sealing technology guarantees perfect tightness (enclosure rating: IP 65, IP 67 and IP 69K)
- Achieving the specified tightening torque of 0,6 Nm ensures the activation of the mechanical vibration protection. This double-acting snap-in lock ensures high shock and vibration strength up to 50 G.
- Integrated fixed stop prevents the plug connector from being screwed too tight
- High-quality material: durability and corrosion resistance verified by Eco-lab certification



→ www.sick.com/F+B_M12

For more information, just enter the link or scan the QR code and get direct access to technical data, CAD design models, operating instructions, software, application examples and much more.





PLH25-D12 / PLH25-M12 / PLV14-A – At a glance

- Ideal for applications with ClearSense and laser photoelectric sensors
- Designed specifically for applications in the food and beverage industry
- Stainless-steel housing for high chemical resistance, particularly to the cleaning agents and disinfectants used in the food and beverage industry
- Housing with hygienic design enables easy, residue-free cleaning
- Hygienic design prevents the build-up of pockets of dirt

→ www.sick.com/Reflectors_and_Optics

For more information, simply enter the link or scan the QR code and get direct access to technical data, CAD design models, operating instructions, software, application examples, and much more.



P250F / PL8FH / PL10FH / PL10F CHEM – At a glance

- Ideal for applications with ClearSens and laser photoelectric sensors
- Easy integration and mounting
- Especially high chemical resistance to cleaning agents and disinfectants
- Reflectors with PC material (PL10FH, PL8FH), temperature range -20 °C ... +99 °C

→ www.sick.com/Reflectors_and_Optics

For more information, simply enter the link or scan the QR code and get direct access to technical data, CAD design models, operating instructions, software, application examples, and much more.



COMPLETE CONSIDERATION OF CUSTOMER REQUIREMENTS

SICK speaks its customers' language, identifies their current requirements, and uses that information to pinpoint future trends. Therefore, SICK has specialized in major industries and the processes which they use. SICK offers a wide range of sensors, systems, and services for process, logistics, and factory automation.

Industry-specific information materials are available.

Waste & Recycling Industry

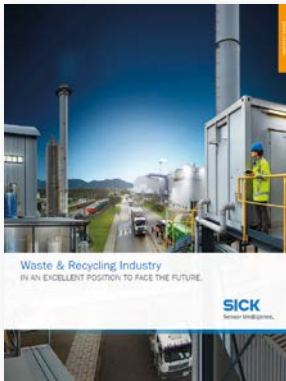

More information about
Waste & Recycling Industry
→ www.sick.com/waste_and_recycling

Printing Industry



More information about
Printing Industry
→ www.sick.com/print

Building Safety and Security



More information about
Building Safety and Security
→ www.sick.com/building_management

Handling and Assembly Technology

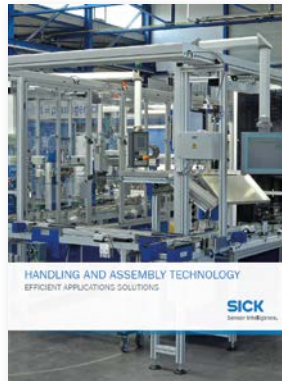

More information about
Handling and Assembly Technology
→ www.sick.com/handling_and_assembly_technology

Power Industry



More information about
Power Industry
→ www.sick.com/power

Rubber and Plastics Industry



More information about
Rubber and Plastics Industry
→ www.sick.com/rubber_and_plastics

Courier, Express and Postal Industry



More information about Courier, Express and Postal Industry
 → www.sick.com/courier_express_parcel_and_postal

Storage and Conveyor



More information about Storage and Conveyor
 → www.sick.com/storage_and_conveyor

Warehouse and Distribution



More information about Warehouse and Distribution
 → www.sick.com/retail_and_warehousing

Material Transport Vehicles



More information about Material Transport Vehicles
 → www.sick.com/industrial_vehicles

Mobile Automation



More information about Mobile Automation
 → www.sick.com/mobile_automation

Machine Tool Industry

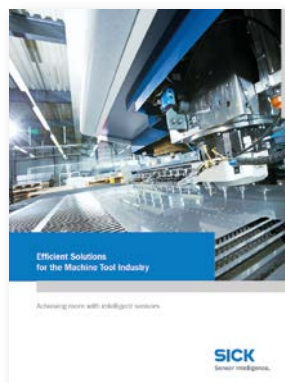

More information about Machine Tool Industry
 → www.sick.com/machine_tools

WE DELIVER “SENSOR INTELLIGENCE.”

SICK sensor solutions for industrial automation are the result of exceptional dedication and experience. From development all the way to service: The people at SICK are committed to investing all their expertise in providing with the very best sensors and system solutions possible.

A company with a culture of success

More than 8,000 people are on staff, with products and services available to help SICK sensor technology users increase their productivity and reduce their costs. Founded in 1946 and headquartered in Waldkirch, Germany, SICK is a global sensor specialist with more than 50 subsidiaries and agencies worldwide. The people work with pleasure at SICK.

This is demonstrated by the accolades that the company is regularly awarded in the “Great Place to Work” competition. This lively corporate culture holds strong appeal for qualified and skilled persons. In SICK, they are part of a company that ensures an excellent balance between career progression and quality of life.



Innovation for the leading edge

SICK sensor systems simplify and optimize processes and allow for sustainable production. SICK operates at many research and development centers all over the world. Co-designed with customers and universities, our innovative sensor products and solutions are made to give a decisive edge. With an impressive track record of innovation, we take the key parameters of modern production to new levels: reliable process control, safety of people and environmental protection.

A corporate culture for sustainable excellence

SICK is backed by a holistic, homogeneous corporate culture. We are an independent company. And our sensor technology is open to all system environments. The power of innovation has made SICK one of the technology and market leaders – sensor technology that is successful in the long term.



“SENSOR INTELLIGENCE.” FOR ALL REQUIREMENTS

SICK is a renowned expert in many industries, and is entirely familiar with the critical challenges they face. While speed, accuracy and availability take center stage in all industries, technical implementations vary greatly. SICK puts its vast experience to use to provide with precisely the solution you need.

For applications worldwide

Hundreds of thousands of installations and applications go to prove that SICK knows the different industries and their processes inside out. This tradition of uncompromising expertise is ongoing: As we move into the future, we will continue

to design, implement and optimize customized solutions in our application centers in Europe, Asia and North America. You can count on SICK as a reliable supplier and development partner.



For your specific industry

With a track record of proven expertise in a great variety of industries, SICK has taken quality and productivity to new heights. The automotive, pharmaceutical, electronics and solar industries are just a few examples of sectors that benefit from our know-how. In addition to increasing speed and improving traceability in warehouses and distribution centers, SICK solutions provide accident protection for automated guided vehicles. SICK system solutions for analysis and flow measurement of gases and liquids enable environmental protection and sustainability in, for example, energy production, cement production or waste incineration plants.

For performance across the board

SICK provides the right technology to respond to the tasks involved in industrial automation: measuring, detecting, monitoring and controlling, protecting, networking and integrating, identifying, positioning. Our development and industry experts continually create groundbreaking innovations to solve these tasks.

→ www.sick.com/industries



SERVICES FOR MACHINES AND SYSTEMS: SICK LifeTime Services

SICK LifeTime Services is a comprehensive set of high-quality services provided to support the entire life cycle of products and applications from plant walk-through to upgrades. These services increase the safety of people, boost the productivity of machines and serve as the basis for our customers' sustainable business success. LifeTime Services range from product-independent consulting to traditional product services and are characterized by extensive industry expertise and 70 years of experience.





→ www.sick.com/service



Consulting and design

- Plant walk-through
- Risk assessment
- Safety concept
- Safety software and hardware design
- Validation of functional safety
- CE-conformance check



Product and system support

- Installation
- Commissioning
- Start-up support
- Calibrations
- Telephone support
- 24-hour helpline
- SICK Remote Service
- Troubleshooting on site
- Repairs
- Exchange units
- Extended warranty



Verification and optimization

- Inspection
- Stop time measurement
- Machine safety inspection
- Electrical equipment check
- Accident investigation
- Initial verification
- Performance check
- Maintenance



Upgrade and retrofits

- Upgrade services



Training and education

- Training
- Seminars
- Web training

VERSATILE PRODUCT RANGE FOR INDUSTRIAL AUTOMATION

From simple acquisition tasks to key sensor technology in a complex production process: With every product from its broad portfolio, SICK offers a sensor solution that best combines cost effectiveness and safety.

[→ www.sick.com/products](http://www.sick.com/products)

Photoelectric sensors

- Miniature photoelectric sensors
- Small photoelectric sensors
- Compact photoelectric sensors
- Cylindrical photoelectric sensors
- Fiber-optic sensors and fibers
- MultiTask photoelectric sensors



Proximity sensors

- Inductive proximity sensors
- Capacitive proximity sensors
- Magnetic proximity sensors



Magnetic cylinder sensors

- Position sensors
- Sensors for T-slot cylinders
- Sensors for C-slot cylinders
- Sensor adapters for other cylinder types



Registration sensors

- Contrast sensors
- Markless sensors
- Color sensors
- Luminescence sensors
- Fork sensors
- Array sensors
- Register sensors
- Glare sensors
- Pattern sensors



Automation light grids

- Measuring automation light grids
- Switching automation light grids

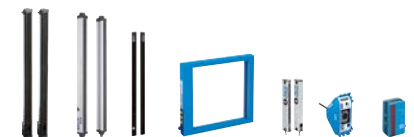

Opto-electronic protective devices

- Safety laser scanners
- Safety light curtains
- Safety camera systems
- Multiple light beam safety devices
- Single-beam photoelectric safety switches
- Mirror columns and device columns
- Upgrade kits for opto-electronic protective devices



Safety switches

- Electro-mechanical safety switches
- Non-contact safety switches
- Safety locking devices
- Safety command devices



sens:Control – safe control solutions

- Safe sensor cascade
- Safety controllers
- Motion Control safety controllers
- Safety relays



Gas analyzers

- Gas transmitters
- In-situ gas analyzers
- Extractive gas analyzers

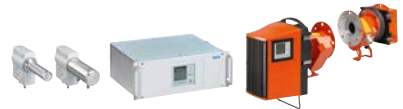

Dust measuring devices

- Scattered light dust measuring devices
- Transmittance dust measuring devices
- Gravimetric dust measuring devices



Analyzer solutions

- CEMS solutions
- Process solutions
- Control units



Traffic sensors

- Tunnel sensors
- Overheight detectors
- Visual range measuring devices



Ultrasonic gas flow measuring devices

- Volume flow measuring devices
- Mass flow measuring devices
- Flow velocity measuring devices
- Gas flow meters
- Flow computers



Identification solutions

- Image-based code readers
- Bar code scanners
- RFID
- Hand-held scanners



Vision

- 2D vision
- 3D vision



Distance sensors

- Displacement measurement sensors
- Mid range distance sensors
- Long range distance sensors
- Linear measurement sensors
- Ultrasonic sensors
- Optical data transmission
- Position finders



Detection and ranging solutions

- 2D LiDAR sensors
- 3D LiDAR sensors
- Radar sensors



Motor feedback systems

- Motor feedback system rotary HIPERFACE®
- Motor feedback system rotary HIPERFACE DSL®
- Motor feedback system rotary incremental
- Motor feedback system rotary incremental with commutation
- Motor feedback system linear HIPERFACE®



Encoders and inclination sensors

- Absolute encoders
- Incremental encoders
- Linear encoders
- Wire draw encoders
- Safety encoders
- Inclination sensors
- Measuring wheel encoders



Fluid sensors

- Level sensors
- Pressure sensors
- Flow sensors
- Temperature sensors



Integration products

- Sensor Integration Machine
- 4Dpro connectivity



System solutions

- Customized analyzer systems
- Driver assistance systems
- Robot guidance systems
- Object detection systems
- Profiling systems
- Quality control systems
- Security systems
- Track and trace systems
- Functional safety systems



Software products

- SICK AppSpace
- Analytics Solutions
- Integrated Managing Solutions



EASY INTEGRATION INTO YOUR AUTOMATION WORLD

In the age of information easy, fast, and manageable access to information is becoming a strategic asset. Our intelligent sensor solutions and safety controllers provide different integration technologies that allow easy access – from HMI, PLC, and engineering tools – to data from our sensors. In this way, we support you towards solving your application rapidly and easily and increase machine availability with a continuous diagnostic concept.

PLC and engineering tool integration

Function Blocks	
IO-Link devices Level sensors Pressure sensors Presence detection sensors Distance sensors	Bar code scanners, Image-based code readers 1D und 2D
Vision sensors Inspector	RFID RFH6xx RFU62x, RFU63x
Absolute encoders AFS60/AFM60	Laser volume flowmeter Bulkscan® LMS511

Function blocks

The SICK function blocks allow you to quickly establish acyclic communication to our sensors within your PLC program. Additionally, complex and variable process data can be parsed into their individual information contents without programming effort.

DTM (Device Type Manager)

FDT/DTM is a cross-manufacturer concept with which configuration and diagnosis of devices from different manufacturers can be done with just one engineering tool.

TCI (Tool Calling Interface)

The Tool Calling Interface (TCI) makes it possible to call up a tool for carrying out parameterization and diagnosis of a field device via the existing communication infrastructure.

HMI integration

OPC server

OPC technology is used to exchange data between field devices and Windows-based applications. The SOPAS OPC server from SICK follows the OPC DA specification and thus can be used on Windows operating systems.



Web server

The SOPAS web server from SICK can be used wherever there is a web browser available. The web server is distinguished by its ability to both carry out pure data exchange and also to provide visualizations for the devices, which is a big advantage, particularly for vision sensors.

Fieldbus and network solutions

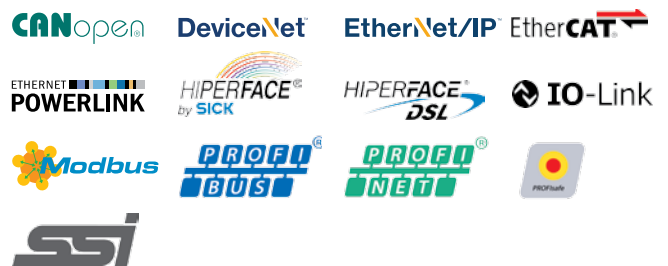

Our fieldbus and network solutions allow SICK sensors and safety controllers to be connected to all conventional automation systems. This guarantees an easy and fast access to the available data.

→ www.sick.com/industrial-communication

REGISTER AT WWW.SICK.COM TO TAKE ADVANTAGE OF OUR FOLLOWING SERVICES FOR YOU



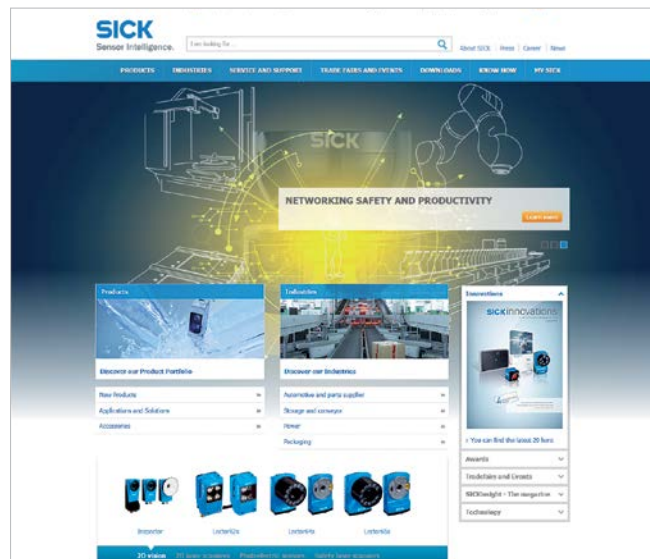

- ✔ Access information on net prices and individual discounts.
- ✔ Easily order online and track your delivery.
- ✔ Check your history of all your orders and quotes.
- ✔ Create, save, and share as many wish lists as you want.
- ✔ Use the direct order to quickly order a big amount of products.
- ✔ Check the status of your orders and quotes and get information on status changes by e-mail.
- ✔ Save time by using past orders.
- ✔ Easily export orders and quotes, suited to your systems.



SERVICES FOR MACHINES AND PLANTS: SICK LifeTime Services

Our comprehensive and versatile LifeTime Services are the perfect addition to the comprehensive range of products from SICK. The services range from product-independent consulting to traditional product services.



- 
Consulting and design
 Safe and professional
- 
Product and system support
 Reliable, fast, and on-site
- 
Verification and optimization
 Safe and regularly inspected
- 
Upgrade and retrofits
 Easy, safe, and economical
- 
Training and education
 Practical, focused, and professional

SICK AT A GLANCE

SICK is a leading manufacturer of intelligent sensors and sensor solutions for industrial applications. With more than 8,000 employees and over 50 subsidiaries and equity investments as well as numerous agencies worldwide, we are always close to our customers. A unique range of products and services creates the perfect basis for controlling processes securely and efficiently, protecting individuals from accidents and preventing damage to the environment.

We have extensive experience in various industries and understand their processes and requirements. With intelligent sensors, we can deliver exactly what our customers need. In application centers in Europe, Asia and North America, system solutions are tested and optimized in accordance with customer specifications. All this makes us a reliable supplier and development partner.

Comprehensive services round out our offering: SICK LifeTime Services provide support throughout the machine life cycle and ensure safety and productivity.

For us, that is “Sensor Intelligence.”

Worldwide presence:

Australia, Austria, Belgium, Brazil, Canada, Chile, China, Czech Republic, Denmark, Finland, France, Germany, Great Britain, Hungary, Hong Kong, India, Israel, Italy, Japan, Malaysia, Mexico, Netherlands, New Zealand, Norway, Poland, Romania, Russia, Singapore, Slovakia, Slovenia, South Africa, South Korea, Spain, Sweden, Switzerland, Taiwan, Thailand, Turkey, United Arab Emirates, USA, Vietnam.

Detailed addresses and further locations → www.sick.com